

Please read this manual carefully before installation and keep it for future reference.

# Installation & Owner's Manual



**MRCOOL®**

COMFORT MADE SIMPLE

**DIY® E Star™ Series**

Due to updates and constantly improving performance, the information and instructions within this manual are subject to change without notice. Please visit [www.mrcool.com/documentation](http://www.mrcool.com/documentation) to ensure you have the latest version of this manual.

Version Date: **03-21-23**

|          |  |    |
|----------|--|----|
| <b>!</b> | <b>Safety Precautions</b>                    |    |
|          | Warnings .....                               | 3  |
|          | Cautions .....                               | 4  |
| <b>1</b> | <b>Parts Overview</b>                        |    |
|          | Parts Diagram .....                          | 6  |
|          | Display Window .....                         | 7  |
|          | Accessories .....                            | 8  |
| <b>2</b> | <b>Operating Instructions</b>                |    |
|          | Operating Temperature .....                  | 10 |
|          | Manual Operation .....                       | 10 |
|          | Airflow Directional Control .....            | 11 |
|          | How the A/C & Heat Pump Work .....           | 12 |
|          | Special Functions .....                      | 13 |
| <b>3</b> | <b>Care and Maintenance</b>                  |    |
|          | Before Maintenance .....                     | 14 |
|          | Cleaning the Unit .....                      | 14 |
|          | Cleaning the Air Filter(s) .....             | 14 |
|          | Preparation for Extended Non-Operation ..... | 15 |
|          | Pre-Season Inspection .....                  | 15 |

## ! IMPORTANT!

### Maximum Line Set Length and Height Specifications\*

| System Capacity   | 12K System      | 18K System      | 24K System      | 36K System      |
|---|-----------------|-----------------|-----------------|-----------------|
| Maximum line set length                                 | 82 ft<br>(25 m) | 98 ft<br>(30 m) | 98 ft<br>(30 m) | 98 ft<br>(30 m) |
| Maximum height difference between indoor & outdoor unit | 33 ft<br>(10 m) | 66 ft<br>(20 m) | 66 ft<br>(20 m) | 66 ft<br>(20 m) |

Units: feet (meters)

\* The table above represents the maximum length and height that the refrigerant line sets can be for each system based on its respective capacity. In order to achieve some of these lengths, line set coupler kits and additional line sets must be used (not included, sold separately). Any attempt to increase the line set length beyond what is specified in the table above, could result in reduced heating/cooling performance, system damage or failure, and **WILL VOID THE WARRANTY**.

**DISCLAIMER:** You are assuming the risk by handling materials containing refrigerants under pressure, that if not handled properly, can cause bodily injury. If you do not feel comfortable conducting this installation process, we recommend you retain the services of a qualified HVAC professional.  
**Electrical work must be completed by a qualified electrical technician.**

- 4 Indoor Unit Installation .....16**
  - 1. Selecting an installation location .....16
  - 2. Attach mounting plate to wall .....17
  - 3. Drill wall hole for connective piping ....17
  - 4. Prepare refrigerant piping .....19
  - 5. Mount indoor unit .....19

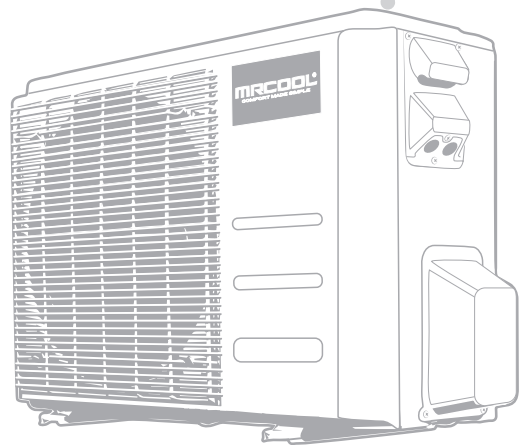

- 5 Outdoor Unit Installation ..... 20**
  - 1. Selecting an installation location ..... 20
  - 2. Install drain joint ..... 21
  - 3. Anchor outdoor unit ..... 22

- 6 Refrigerant Piping Connections ..... 24**
  - 1. Prepare Exterior Wall Hole ..... 24
  - 2. Unwind Quick Connect® Line Set\* to necessary length 24
  - 3. Connect Line Set to Indoor Unit ..... 25
  - 4. Connect Line Set to Outdoor Unit ..... 27
  - 5. Opening Refrigerant Valves of Outdoor Unit ..... 29
  - 6. Wrap Piping Connections ..... 30
  - 7. Connect drain pipe ..... 31
- 7 Electrical Connections ..... 33**
- 8 Electrical and Gas Leak Checks ..... 36**
- 9 Test Run ..... 37**
- 10 Troubleshooting ..... 39**
  - Indoor Error Unit Display ..... 41
  - Troubleshooting by Error Code ..... 43
- 11 EU Disposal Guidelines ..... 58**

\*Pat. <https://mrcool.com/mrcool-patents/>

# Safety Precautions



## Read Before Using

**Incorrect usage may cause serious damage or injury.**

The symbols below are used throughout this manual to indicate instructions that should be followed closely or actions that should be avoided to prevent death, injury, and/or property damage.



**WARNING**

**This symbol indicates ignoring instructions may cause death or serious injury.**



**CAUTION**

**This symbol indicates ignoring instructions may cause bodily injury, damage to the unit, or other surrounding property.**



**This symbol indicates that you should NEVER perform the indicated action.**



## **WARNING**

**DISCLAIMER:** You are assuming risk by handling materials containing refrigerants under pressure, that if not handled properly can cause bodily injury. If you do not feel comfortable performing this installation process, we recommend you retain the services of a qualified HVAC professional.

**\*\*\*\*ELECTRICAL WORK MUST BE COMPLETED BY A QUALIFIED ELECTRICAL TECHNICIAN\*\*\*\***

- ⊘ **DO NOT** share the electrical circuit with other appliances. You must use an independent power supply. An improper or insufficient power supply could cause fire or electrical shock.
- ⊘ **DO NOT** allow any substances or gases to enter the unit when connecting the refrigerant piping. The presence of other gases or substances will lower the unit's capacity, and may cause abnormally high pressure during the operation cycle. This could cause an explosion and/or injury.
- ⊘ **DO NOT** allow children to play with the air conditioner. Children should be supervised around the unit at all times.
- ⊘ **DO NOT** insert your fingers, rods, or other objects into the air inlet or outlet. The fan within the unit could be rotating at high speeds and could cause injury.
- ⊘ **DO NOT** use flammable sprays such as hair spray, lacquer, or paint near the unit. These could cause fire and/or an explosion.
- ⊘ **DO NOT** operate the unit in places where it could be exposed to or near combustible gas. Emitted gas could collect around the unit and cause an explosion.
- ⊘ **DO NOT** operate the unit in a room where it could be exposed to excessive amounts of water (such as a bathroom or laundry room). Too much exposure to water can cause electrical components to short circuit.
- ⊘ **DO NOT** expose your skin or body directly to the cool air coming from the unit for a prolonged period of time.
- ⊘ **DO NOT** install the unit within 3 ft (1 m) of any combustible gas if the unit is equipped with an auxiliary heater.
- ⊘ **DO NOT** operate the air conditioner with wet hands. This could cause electrical shock.
- ⊘ **DO NOT** turn on the power until the installation has been completed.

## **WARNING**

- ⚠ **DO NOT** pull the power cord to unplug the unit. Hold the plug firmly and pull it from the outlet. Pulling directly on the cord can damage it, which could lead to fire and/or electric shock.
- ⚠ **DO NOT** modify the length of the power supply or use an extension cord to power the unit.
  1. Installation must be performed according to the installation instructions. Improper installation could cause water leakage, electrical shock, fire, and could void the warranty.
  2. If the unit operates abnormally (emits strange noises or a burning smell), immediately turn off the unit and disconnect the power in order to avoid electric shock, fire, and/or injury. Call your local dealer, or MRCOOL tech support at (270) 366-0457, for further assistance.
  3. In North America, service or repair must be performed in accordance with the requirements of NEC and CEC (by authorized personnel or authority having jurisdiction only). Contact an authorized service technician for repair or maintenance of the unit.
  4. Only use the included accessories and specified parts for installation. Using non-standard parts can cause water leakage, electrical shock, fire, and may cause the unit to fail.
  5. Install the unit in a firm, stable location that can support its weight. If the installation location cannot support the weight of the unit, it could fall and cause serious injury and/or damage.
  6. Appropriate wiring standards, regulations, and the installation manual must be followed for all electrical work.
  7. If connecting power to fixed wiring, the following must be incorporated within it, in accordance with the wiring rules; an all-pole disconnection device (which has at least 3 mm of clearances in all poles), and have a leakage current that may exceed 10 mA, the residual current device (RCD) having a rated residual operating current not exceeding 30 mA, all must be present.
  8. For all electrical work, fuse the specified cables. Connect cables tightly and clamp them securely to prevent external forces from damaging the terminal. Improper electrical connections could overheat, causing fire and/or electrical shock.
  9. All wiring must be properly arranged to ensure that the control board cover can close properly. If the control board cover is not closed properly, it can lead to corrosion, which can cause the connection points on the terminal to overheat, which could result in fire and/or electric shock.
  10. In certain functional environments (such as kitchens and server rooms etc.), the use of specially designed air-conditioning units is highly recommended.
  11. If the supply cord is damaged, it must be replaced by the manufacturer, its service agent, or a similarly qualified person in order to avoid a hazard.
  12. This appliance can be used by children (8 years and older) and persons with reduced physical, sensory or mental capabilities, or lack of experience and knowledge if they have been given instruction concerning the use of the appliance and understand the hazards involved. Children should not play with the appliance. Cleaning and user maintenance should not be performed by children.
  13. If the air conditioner is used together with burners or other heating devices, thoroughly ventilate the room in order to avoid an oxygen deficiency.
  14. Contact an authorized service technician for repair or maintenance of this unit.
  15. Install drainage piping according to the instructions in this manual. Improper drainage may cause water damage to your home and property.
  16. When moving or relocating the air conditioner, consult experienced service technicians for disconnection and re-installation of the unit.
  17. The product must be properly grounded during installation or electrical shock could occur.
  18. For more information on how to install the appliance to its support, please refer to the indoor unit installation and outdoor unit installation sections of this manual.
  19. Keep the power plug clean and remove dust or grime that accumulates around the plug. A dirty plug could cause fire or electric shock.

## **WARNING for Using R-32/R-290 Refrigerant**

1. When flammable refrigerants are employed, the appliance should be stored in a well-ventilated area where the size of the room corresponds to the area size required for the operation of the unit.
  - **For R-32 refrigerant models:**  
The appliance should be installed, operated, and stored in a room with a floor area larger than 4m<sup>2</sup>. The appliance should not be installed in an unventilated space, if the space is smaller than 4m<sup>2</sup>.
  - **For R-290 refrigerant models, the minimum room size needed:**
    - For units with a capacity less than or equal to 9,000 Btu/h: 13m<sup>2</sup>
    - For units with a capacity greater than 9,000 Btu/h and less than or equal to 12,000 Btu/h: 17 m<sup>2</sup>
    - For units with a capacity greater than 12,000 Btu/h and less than or equal to 18,000 Btu/h: 26 m<sup>2</sup>
    - For units with a capacity greater than 18,000 Btu/h and less than or equal to 24,000 Btu/h: 35 m<sup>2</sup>
2. Reusable mechanical connectors and flared joints are not allowed indoors (EN Standard Requirements).
3. Mechanical connectors used indoors should have a rate of not more than 3g/year at 25% of the maximum allowable pressure. When mechanical connectors are reused indoors, sealing parts should be renewed. When flared joints are reused indoors, the flared end should be re-fabricated (IEC Standard Requirements).

## **Note about Fluorinated Gases:**

1. This unit contains fluorinated greenhouse gases.
2. For specific information on the type of gas and the amount, please refer to the relevant label on the unit itself.
3. Service, maintenance, and repair of this unit must be performed by a certified technician.
4. Product un-installation and recycling must be performed by a certified technician.
5. For equipment that contains fluorinated greenhouse gases in quantities of 5 tonnes of CO<sub>2</sub> equivalent or more, but less than 50 tonnes of CO<sub>2</sub> equivalent, and has a leak-detection system installed, it must be checked for leaks at least every 24 months.
6. Keeping a record of all leak checks for the lifetime of the unit is strongly recommended.

**NOTE: The installation must be performed in accordance with the requirement of local and national standards. The installation may be slightly different in different areas.**

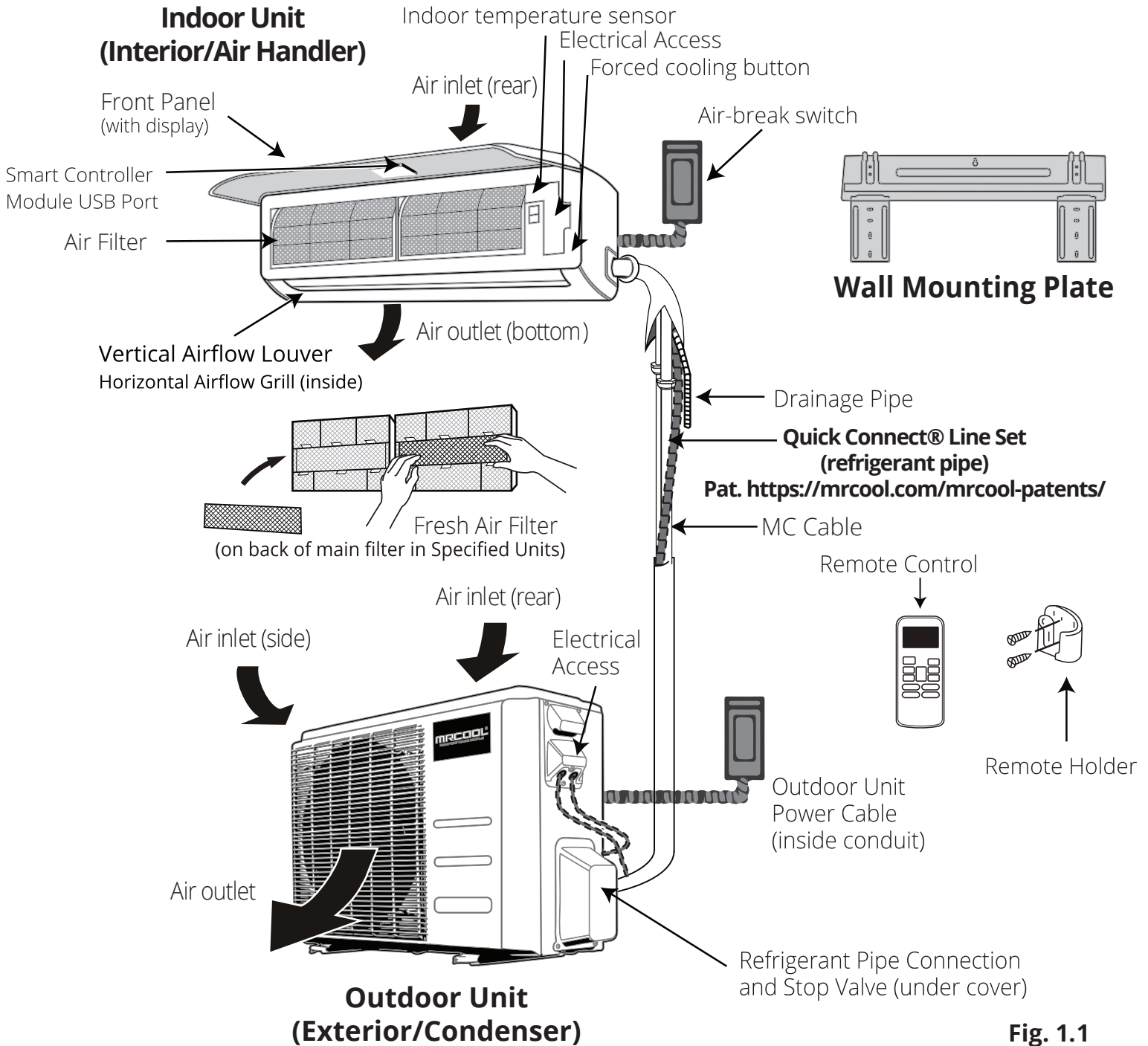

**Fig. 1.1**

## NOTE ON ILLUSTRATIONS

Illustrations in this manual are for explanatory purposes. The actual shape of your unit may vary.



# Overview - Indoor Unit Display

**NOTE:** Different models will have a different front panel and display window. Not all of the features listed below will be equipped on the unit you have purchased. Please check the indoor unit display window of the unit purchased to see which of these features your unit has.

Illustrations in this manual are for explanatory and demonstration purposes only. The actual shape of your and size of your indoor unit may be different.

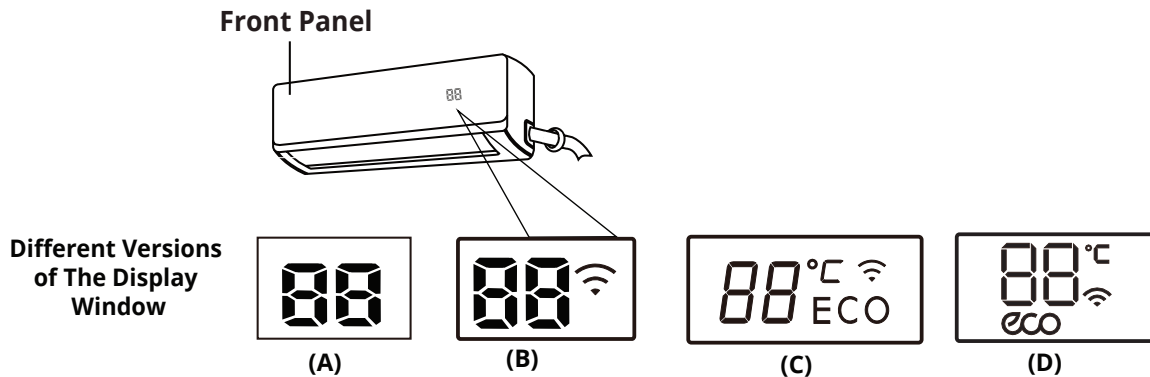

Fig. 1.2

## Display Code Meanings

**ECO** When ECO function is activated (some units)

**°C** Units of measure, displays as either °C (Celcius) or °F (Fahrenheit). It will display in a different color depending on the mode the unit is operating in:

- Under COOL or DRY mode, it will display as a cool color (Blue).
- Under HEAT mode it will display as a warm color (Red).

**Wi** This will display when the Wireless Control feature is activated (some units).

**88** This is the temperature display and will also display operational features and error codes:

**ON** will display for 3 seconds when:

- **TIMER ON** is set (if the unit is OFF, **ON** will remain on the display screen when the Timer On is set).
- **SWING, TURBO, SILENCE, or SOLAR PV ECO** features are turned on.

**OF** will display for 3 seconds when:

- **TIMER OFF** is set.
- **SWING, TURBO, SILENCE, or SOLAR PV ECO** features are turned off.

**cF** will display when the anti-cold air feature is activated.

**dF** will display when the unit is defrosting (cooling & heating units).









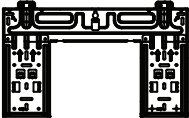
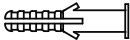

**SC** will display when the unit is self-cleaning.

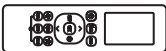
**FP** will display when the 46.4°F (8°C) heating feature is activated.

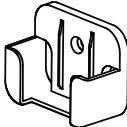









# Accessories

The listing below shows the accessories and parts (these may vary depending on purchase & options). Use all of the installation parts and accessories to install the system. Improper installation may result in water leakage, electrical shock, fire, and/or equipment failure.

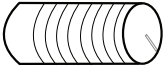
| PART  | LOOKS LIKE...   | QUANTITY                       |                   |
|---|---|--------------------------------|-------------------|
| Mounting plate                                |    | 1                              |                   |
| Anchor  |    | 5~8<br>(depending on models)   |                   |
| Mounting plate fixing screw                   |    | 5~8<br>(depending on models)   |                   |
| Remote control                                |    | 1                              |                   |
| Fixing screw for remote controller holder     |    | 2                              | Optional<br>Parts |
| Remote Controller Holder                      |   | 1                              |                   |
| Allen Wrench                                  |  | 1                              |                   |
| Neoprene                                      |  | 1<br>(Sealant for Wall Sleeve) |                   |
| Batteries                                     |  | 2                              |                   |
| Small Filter                                  |  | 1                              |                   |
| Seal<br>(for cooling & heating models)        |  | 1                              |                   |
| Drain joint<br>(for cooling & heating models) |  | 1                              |                   |

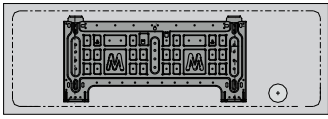
*Note: Illustrations are for explanatory purposes only - The actual shape and size may vary.*

# Accessories

| PART  | LOOKS LIKE...   | QUANTITY   |
|---|---|--|
| Installation & Owner's Manual               |    | 1  |
| Remote Control Manual                       |    | 1  |
| Smart Controller Kit                        |    | 1<br>(w/ Manual in Controller Box)               |
| Plastic Wall Sleeve                         |    | 1  |
| Sound Deadening Pads                        |    | 2  |
| Drain Pipe                                  |    | 1<br>16 ft (5 m)                                 |
| Cardboard Mounting Plate Template           |  | 1  |
| Quick Connect® Line Set* (refrigerant pipe) |  | 1  |
| Insulation Material                         |  | 2<br>(Apply to the quick connectors of the pipe) |
| Non-Adhesive U.V. Tape                      |  | 1  |

\*Pat. <https://mrcool.com/mrcool-patents/>

## Operating Temperature Ranges

|                            | COOL Mode  | HEAT Mode  | DRY Mode                            |
|----------------------------|--|--|-------------------------------------|
| <b>Room Temperature</b>    | <b>62°F - 90°F</b><br>(17°C - 32°C)  | <b>32°F - 86°F</b><br>(0°C - 30°C)   | <b>50°F - 90°F</b><br>(10°C - 32°C) |
| <b>Outdoor Temperature</b> | <b>12K-24K Capacity</b><br>-13°F - 122°F<br>(-25°C - 50°C)<br><b>36K Capacity</b><br>5°F - 122°F<br>(-15°C - 50°C) | <b>12K-24K Capacity</b><br>-13°F - 75°F<br>(-25°C - 24°C)<br><b>36K Capacity</b><br>5°F - 75°F<br>(-15°C - 24°C) | <b>32°F - 122°F</b><br>(0°C - 50°C) |

### NOTES:

- If the air conditioner operates for extended periods in cooling mode and the humidity is high (over 80%), condensed water may drip out of the unit. If this occurs, set the vertical airflow louver to its maximum angle (vertical toward the floor), and set it to **HIGH** fan mode.
- Optimum performance will be achieved within the above operating temperatures. If the air conditioner is operated outside of the above temperatures, certain safety protection features might be activated and cause the unit to function abnormally.
- **FOR OUTDOOR UNITS WITH AUXILIARY ELECTRIC HEATER:** When the outside temperature is below 32°F (0°C), we strongly recommend keeping the unit plugged in at all time to ensure smooth ongoing performance.

## Manual Operation (without remote)

### ! CAUTION

The manual control button is intended for testing purposes and emergency operation only. Please do not use this function unless the remote control is lost and it is absolutely necessary. To restore regular operation, use the remote control to activate the unit. **THE UNIT MUST BE TURNED OFF BEFORE THE MANUAL OPERATION FUNCTION CAN BE ACTIVATED.**

### To operate the unit manually, follow these steps:

1. Open the front panel of the indoor unit.
2. Locate the **MANUAL CONTROL BUTTON** on the right-hand side of the unit.
3. Press the **MANUAL CONTROL BUTTON** one time to activate the **FORCED AUTO MODE**.
4. Press the **MANUAL CONTROL BUTTON** a second time to activate the **FORCED COOLING FUNCTION**.
5. Press the **MANUAL CONTROL BUTTON** a third time to turn the unit off.
6. Close the front panel.

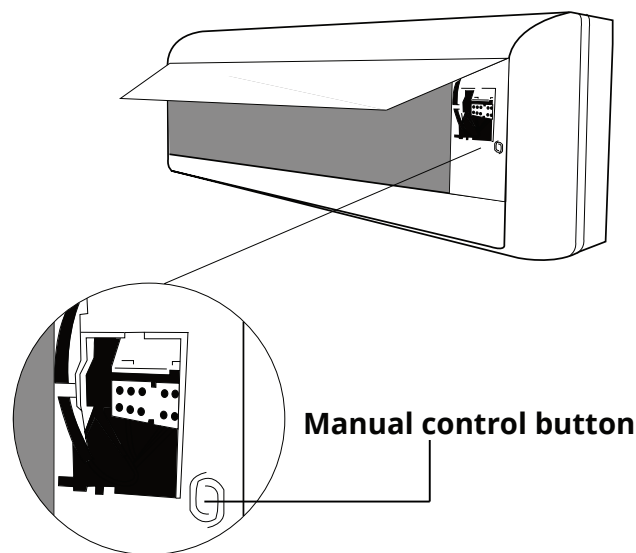

Fig 2.1

## Airflow Directional Control

- Adjustment of the vertical and horizontal louvers will change airflow direction of the indoor unit to prevent discomfort and/or uneven room temperatures.
- **Adjust the vertical louver using the remote.**
- **Adjust the horizontal louver manually by hand.**

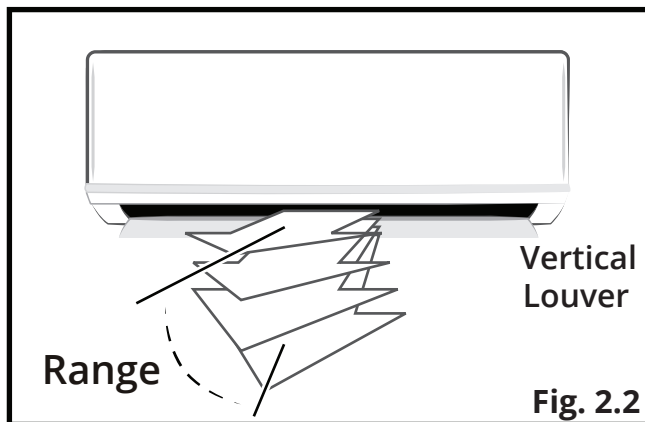
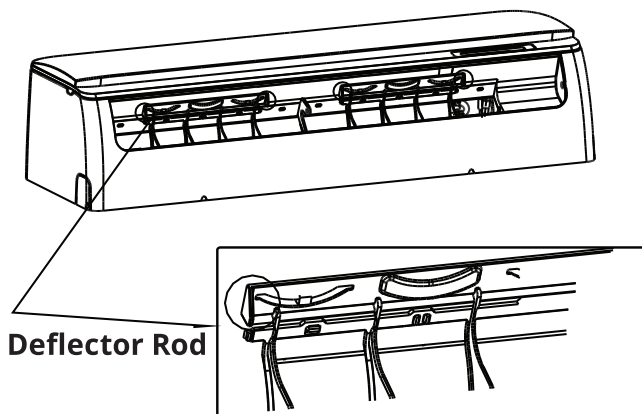

Fig. 2.2



Horizontal Louver  
(Horizontal Airflow  
Grill inside)

Fig. 2.3

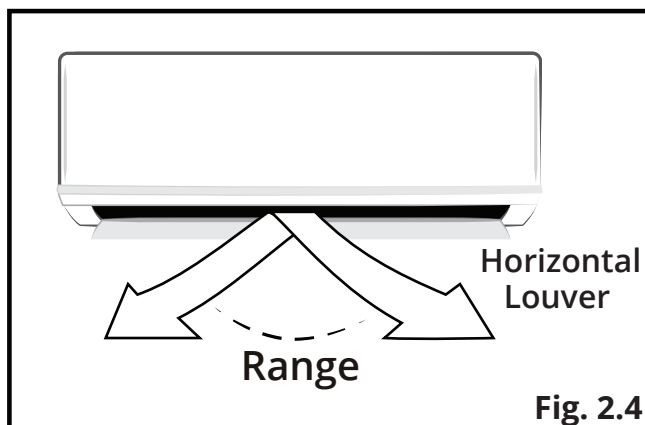

Fig. 2.4

## Adjust Vertical Airflow (Up/Down) using Vertical Louver (Fig 2.2):

This function is performed by using the **SWING/DIRECT** button on the remote control, while the unit is operating. The Vertical louver can move in small increments for each press, or continuously swing up and down automatically. Please refer to the "**Remote Control User Manual**" for further details.

## Adjust Horizontal Airflow (Left/Right) using Horizontal Louver (Fig 2.3 & Fig 2.4)

The angle of the horizontal louver must be set manually. Move the deflector rod, located on the underside of the unit, by pushing the tab to manually adjust the airflow from side to side as desired. For some units, the horizontal angle of the airflow can be set by the remote control. Please refer to the "**Remote Control User Manual**" for further details.

## ! CAUTION

- ⚠ **DO NOT** put your fingers into the panel of the blower and suction side. The high speed fan inside may cause injury.
- ⚠ **DO NOT** operate the unit for extended periods of time in COOL or DRY mode with the vertical airflow direction set with too much of a downward angle. This could cause condensation to form on the surface of the vertical louver and allow moisture/water droplets to drop onto furnishings or the floor.
- ⚠ **DO NOT** move the vertical louver manually, as this could cause it to become out of sync. If this occurs, follow these steps:

1. Turn off the power to the unit.
2. Remove the wireless module from the back of the front cover.
3. Turn off the power to the circuit at the breaker.
4. Wait a few seconds and turn the power back on at the breaker.
5. Reinstall the wireless module into the front cover.
6. Turn the power to the unit back on.

**NOTE:** After a quick restart, the vertical louver may remain static for approximately 10 seconds.

**NOTE:** The open angle of the vertical louver should not be set too small when using COOL or HEAT mode, as it will restrict airflow and reduce performance of the unit.

## How the Air Conditioner Works

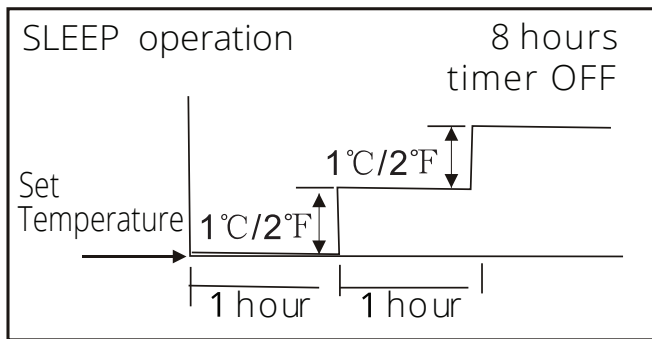

**SLEEP Operation While Cooling**

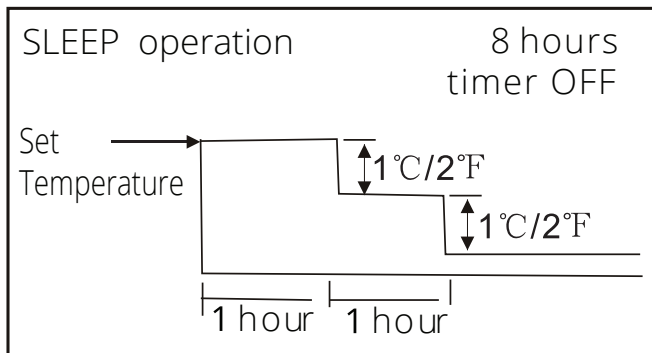

**SLEEP Operation While Heating**

## Basic Operation Modes:

**AUTO / COOL / DRY / HEAT (Model Dependent).**

### AUTO Mode:

When you set the unit in **AUTO** mode, it will automatically select **COOL**, **HEAT**, or **FAN-ONLY** mode depending on the set temperature and the room temperature.

The unit will control the room temperature automatically, according to the temperature you set the unit to.

### DRY Mode:

The temperature is regulated while dehumidifying by intermittently switching the **COOL** or **FAN-ONLY** modes on and off. The fan speed is set to **LOW**.

### HEAT Mode:

The unit is a heat pump by design. By reversing the air conditioning process, it absorbs heat from the outdoors and transfers it to the indoor unit. As a result, the operating performance and efficiency is reduced as the outdoor air temperature drops. If you feel that the heating performance is insufficient, it is recommended that you supplement heating with other appliances.

### SLEEP Mode:

The **SLEEP** function is used to decrease energy use while you sleep. During sleep you do not need the same temperature settings to stay comfortable. This function can only be activated via the remote control. The **SLEEP** function is not available in **FAN** or **DRY** modes.

When **SLEEP** mode is activated, the temperature will increase while cooling, or decrease while heating by, 2°F (1°C) per hour for the first 2 hours. Thereafter, it keeps this new temperature for 6 hours before **SLEEP** mode will automatically switch off.

## Optimal Operation

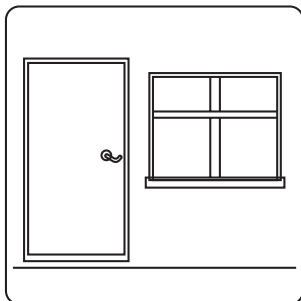

**Doors and windows should be kept closed.**

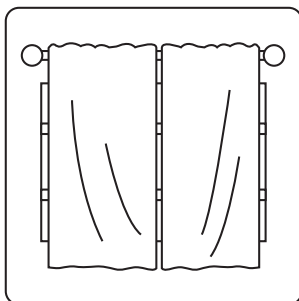

**Closing the curtains while heating also helps keep the heat in**

To achieve optimal performance, please note the following:

- ⚠ **DO NOT** put any objects near the air inlets/outlets. Doing this would impair performance and could cause the unit to shut down.
- Adjust the airflow direction correctly, so that it is not towards people or at an extreme angle.
- Adjust the temperature to achieve moderate comfort levels. An excessively low or high temperature setting wastes energy.
- Keep windows and doors closed, as this will improve performance.
- Limit energy usage (run time) using the **TIMER** function.
- Inspect the air filters periodically, and clean them as needed.

## Special Functions

### Refrigerant Leakage Detection:

When refrigerant leakage is detected, the indoor unit will display "EC" or "ELOC" code or flash LEDs.

### Louver Angle Memory Function (some units):

Within the scope of the safe operation angle, the horizontal louver angle is memorized and returns to the position last selected by the user. If it exceeds the safe operation angle, it will default within the safe operation range. However, it will not return to safe operation angle when Turbo mode is set or the unit is in manual control or after a power interruption. Subsequently, it is strongly recommended that the horizontal louver angle not be set too small, to avoid possible condensation leakage.

### Anti-Mildew Function (some units):

When the unit is turned off, in **COOL**, **DRY**, or **AUTO** (COOL) modes, it will continue to operate at very low power. This is to aid in drying any condensation that has formed inside the unit to prevent mildew growth.

### Auto-Restart (some units):

In the event of a power interruption such as a blackout, the air conditioner will stop. It will then restart automatically and resume the previous operation when the power supply returns.

### Wireless Smart Control Function:

Connect the wireless control module via the USB port in the back of the front cover of the indoor unit. This will allow the unit to be controlled by remote control and/or the smartphone app. For the USB device access, replacement, and maintenance operations must be carried out by professional staff.

### Clean Air Filter Reminder (optional):

After 240 hours of operation, the indoor display window will display and flash "CL" as a reminder to **CLEAN** the air filter for more efficient operation. After 15 seconds, the system will revert back to the previous display again. When the "CL" indicator appears and flashes, please press the **LED** button on the remote control 4 times or press the manual control button 3 times to reset the hours. If you don't reset the reminder, the "CL" indicator will flash again when you restart the unit.

### Replace Air Filter Reminder (optional):

After 2880 hours of operation, the indoor display window will display and flash "nF" as a reminder to **REPLACE** the air filter for more efficient operation. After 15 seconds, the system will revert back to the previous display again. When the "nF" indicator appears and flashes, please press the **LED** button on the remote control 4 times or press the manual control button 3 times to reset the hours. If you don't reset the reminder, the "nF" indicator will flash again when you restart the unit.

### Mute Function (optional):

Press the **LED** button on the remote to turn off the **LED** display and silence the buzzer of the indoor unit, creating a quiet comfortable environment.

## ! CAUTION

The power supply must be disconnected before attempting any kind of cleaning or service. Before performing maintenance, turn the power off to the unit and then disconnect the power to the circuit at the breaker. Failure to do this could cause electrical shock and injury.

- ⊘ **DO NOT** use benzene, thinner, polishing powder, or similar solvents for cleaning. These could cause the plastic to deform and/or crack.
- ⊘ **DO NOT** clean the unit with excessive amounts of water.
- ⊘ **DO NOT** touch the metal parts of the unit when removing the filter. Injuries can occur when handling the sharp metal edges.
- ⊘ **DO NOT** use water to clean the inside of the unit. Exposure to water can destroy the insulation, which could lead to electric shock.

- ⊘ **DO NOT** use a chemically treated cloth or duster to clean the unit.
- ⊘ **DO NOT** touch the air freshening (Plasma) filter for at least 10 minutes after turning off the unit.
- ⊘ **DO NOT** clean the unit with combustible cleaning agents. These could cause fire and/or deformation of the unit.
- ⊘ **DO NOT** wash the air filter with water hotter than 104°F (40°C).
- ⊘ **DO NOT** expose the filter to direct sunlight, as this could cause it to shrink. Allow the filter to dry in the shade.

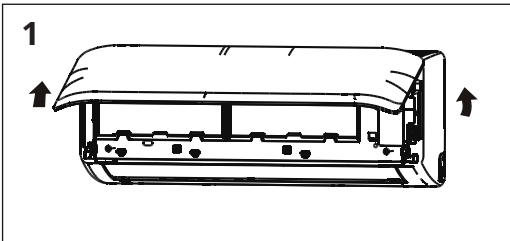

### Cleaning the Unit:

Wipe the unit with a soft dry cloth. If the unit is very dirty, wipe it with a cloth soaked in warm water.

- ⊘ **DO NOT** use bleach or abrasives.

### Cleaning the Air Filter and Air Freshener:

**NOTE: A clogged air filter can greatly reduce heating and cooling efficiency of this unit. It is recommended to clean the unit every 2 weeks.**

1. Open the front by carefully lifting both ends at the same time. As you continue lifting, at a certain angle there will be an audible click and the lid will become self-supporting. Some models are equipped with suspension bars that are required to prop the lid open.
2. Use the filter tabs to lift filter slightly upward and then pull it toward you.

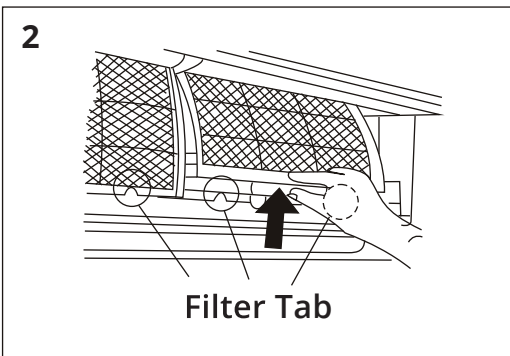



# Care and Maintenance

3. Then, extract the filter by gently drawing it downward. Replace as necessary.
4. Unclip the small air freshening filter from the larger air filter. Replace if necessary. Otherwise, clean it with a vacuum and clip it back into place after cleaning the larger air filter as outlined in step 5.
5. Clean the large air filter with warm, soapy water. Be sure to use a mild detergent and rinse with fresh water. Shake off the excess water and allow it to dry in a cool area.
6. Re-clip the small air freshening filter into the larger air filter.
7. Re-fit air filter back into the unit by reversing steps 2 and 3 by gently pushing the top of the filter up into the unit and then lowering the bottom portion into place.
8. Close the front panel of the unit. Make sure that it buckles securely and the panel is completely closed.

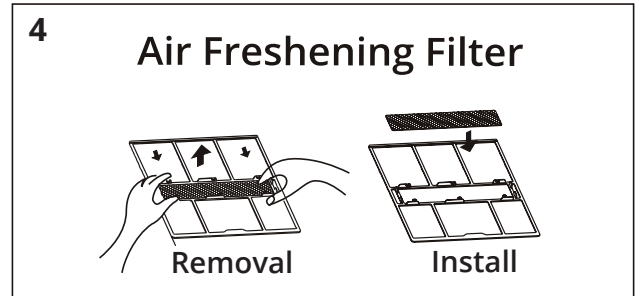
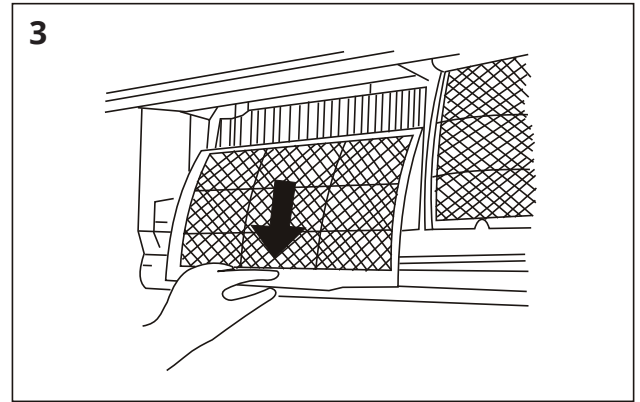

## Preparation for Extended Non-Operation:

If you plan to not run the unit for an extended period of time (e.g. from the end of summer to the beginning of the following summer), perform the following:

1. Clean the indoor unit and filters as outlined in the previous steps.
2. Operate the unit in **FAN-Only** mode for at least 8 hours to dry out the inside of the unit.
3. Turn off the unit. Then, turn off the power to the circuit at the breaker. The unit should be the only appliance on this circuit.
4. Remove the batteries from the remote control.
5. The outdoor unit also requires periodic maintenance. However, it is highly recommended you contact a qualified service professional to perform this. Please do not attempt to do this on your own.

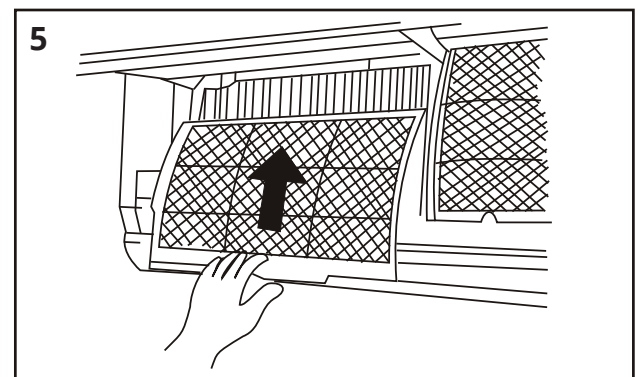

## Pre-Season Inspection:

After prolonged non-operation perform the following:

1. Check for damaged or disconnected wires.
2. Clean the indoor unit and filters.
3. Check for water and oil leaks.
4. Check for blockages in the airflow inlet and outlet.
5. Replace batteries in the remote control.

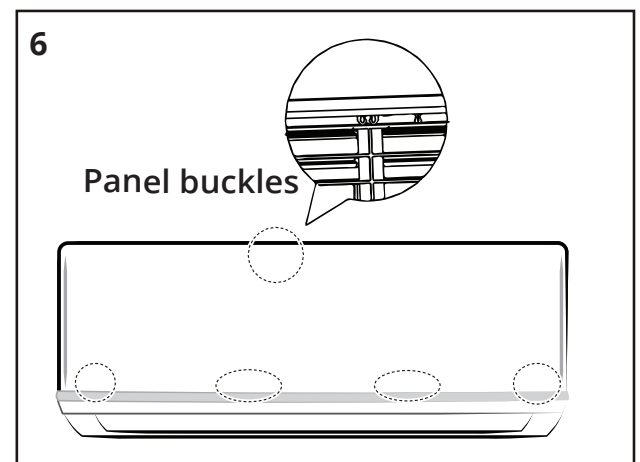

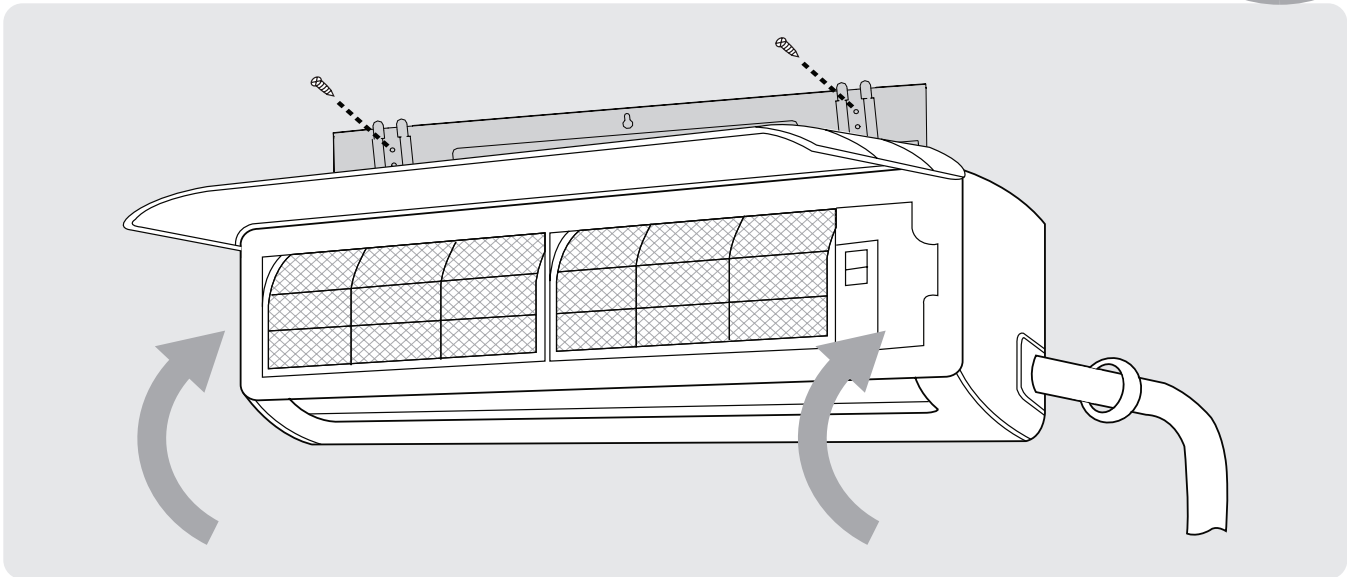

## Installation Instructions - Indoor Unit

### PRIOR TO INSTALLATION:

Before installing the indoor unit, refer to the label on the product box to make sure that the model numbers of the indoor unit and outdoor unit match.

### Step 1: Selecting an installation location

Before installing the indoor unit, you must choose an appropriate location. The following standards and guidelines will help you choose an appropriate location for the unit.

#### Proper installation locations should meet the following standards:

- ✓ Good air circulation
- ✓ Convenient drainage
- ✓ Noise from the unit will not disturb other people
- ✓ Firm and solid location that will not vibrate
- ✓ Strong enough to support the weight of the unit.
- ✓ A location that is at least 1 meter from all other electronic devices (e.g., TV, radio, computer)

#### ***DO NOT*** install the indoor unit in the following locations:

- ⊘ Near any source of heat, steam, or combustible gas.
- ⊘ Near flammable items such as curtains or clothing.
- ⊘ Near any obstacles that could block air circulation.
- ⊘ Near a doorway or where outside air may blow directly on the indoor unit.
- ⊘ In a location subject to direct sunlight exposure.

#### **NOTE ABOUT WALL HOLE**

If there is no fixed refrigerant piping: While choosing a location, be sure that you leave ample room for a wall hole (see the Drill Wall Hole for Connective Piping step on the following pages) for the signal cable and refrigerant piping, which connect the indoor and outdoor units. The default position for all piping is the right-hand side of the indoor unit (while facing the front of the unit). After the piping and signal wire are installed, use the provided neoprene (spray foam can be used instead, if you prefer) to pack the space left in hole, in order to seal it and make it airtight.

Refer to Fig. 4.2 to ensure proper distance from walls, ceiling, and floor when mounting unit:

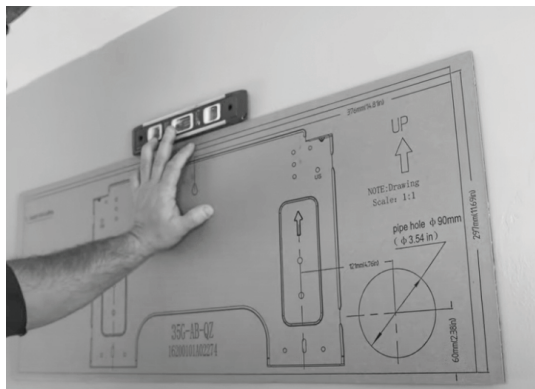

Fig. 4.1

## Step 2: Attach Mounting Plate to Wall

You must drill a hole in the wall for the refrigerant piping, drainage pipe, and signal cable to pass through in order to connect the indoor and outdoor units.

1. Remove the screw that attaches the mounting plate to the back of the indoor unit.
2. Place the mounting plate against the wall in a location that meets the guidelines in the **Selecting an Installation Location** step. Refer to the **Mounting Plate Dimensions** section for detailed information on mounting plate sizes.

### NOTE

A cardboard template of the mounting plate is included to be used as a more manageable way of determining where to mount the mounting plate and drill the wall hole. It can be placed against the wall in place of the actual mounting plate for the previous step (See Fig 4.1).

3. Drill holes for wall plate mounting screws in places that have the following:
  - studs that can support the weight of the unit.
  - correspond to the holes in the mounting plate.
4. Secure the mounting plate to the wall with the supplied screws.
5. Make sure that the mounting plate is flat against the wall.

### NOTE FOR CONCRETE OR BRICK WALLS:

If the wall is made of brick, concrete, or a similar material, drill 0.2 in (5 mm) diameter holes in the wall and insert the sleeve anchors provided. Secure the mounting plate to the wall by tightening the screws directly into the anchors.

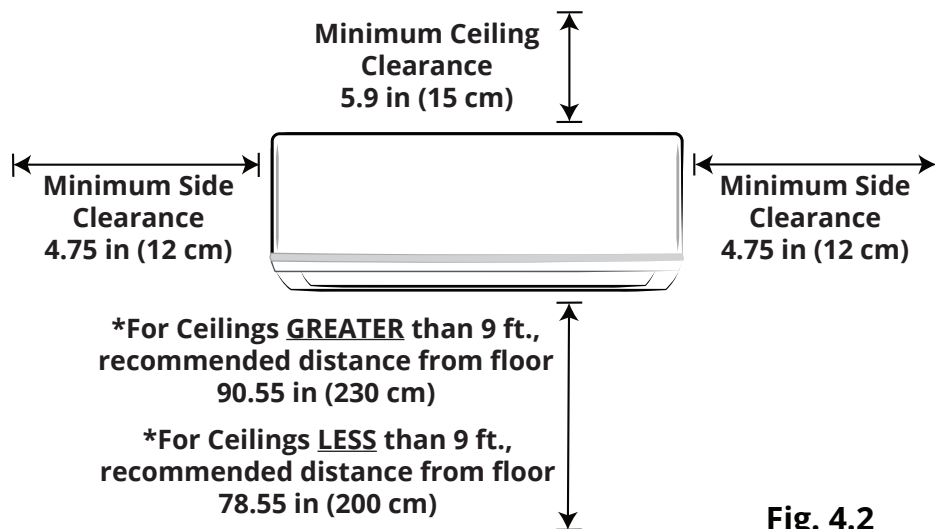

Fig. 4.2

## Step 3: Drill Wall Hole for Connective Piping

You must drill a hole in the wall for the refrigerant piping, drainage pipe, and signal cable to pass through in order to connect the indoor and outdoor units.

1. Determine the location of the wall hole based on the position of the mounting plate. Refer to the **Mounting Plate Dimensions (See Fig 4.5)** to assist you in determining the optimal position for the hole, based on the type of mounting plate provided with your unit.
2. Using a core drill, with a 3.54 in (90 mm) diameter, drill a hole in the wall at a slight downward angle, so that the indoor end of the hole is higher than the outdoor end of the hole, by approximately 0.2 in to 0.275 in (5 mm to 7 mm). This will ensure proper water drainage from the indoor unit (See Fig. 4.3).
3. Insert the protective wall sleeve through the hole of the inside wall, noting the amount it protrudes from the exterior wall. Then, trim the excess, with a utility knife or a saw, to make it flush with the exterior wall. This will protect the edges of the hole and help seal it when you finish the installation process (See Fig 4.4).

### ! CAUTION

When drilling the wall hole, be sure to avoid wires, plumbing, nails, screws, and other sensitive components.

# Indoor Unit Installation

## MOUNTING PLATE DIMENSIONS

Different models have different mounting plates. In order to ensure that you have ample room to mount the indoor unit, the diagrams to the right show different types of mounting plates along with the following dimensions:

- Height & Width of mounting plate
- Height & Width of indoor unit relative to plate
- Recommended position of wall hole
- Relative distances between mounting holes

⊘ **DO NOT** attempt a left rear wall hole.

### Correct orientation of Mounting Plate

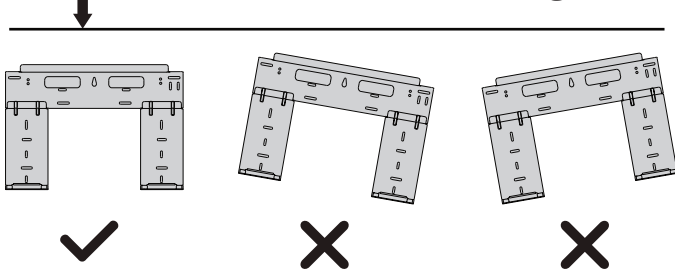

**NOTE:** Use a level in order to ensure your mounting plate is mounted to the wall with the correct orientation shown above.

### Correct Angle to Drill Wall Hole

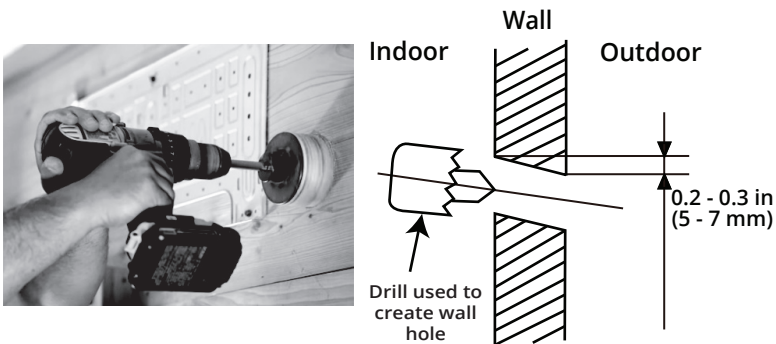

Fig. 4.3

### Wall Hole Sleeve Installation



Fig. 4.4

## NOTE REGARDING WALL STUDS

- Wall Mounting Bracket should be installed on studs.
- Standard U.S. studs are 16 in (406.4 mm) on center.
- Studs that are 16 in (406.4 mm) on center correlates with the holes marked "US" on the metal bracket.

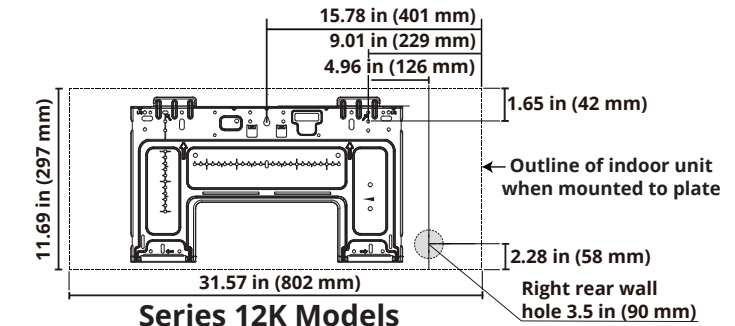

Series 12K Models

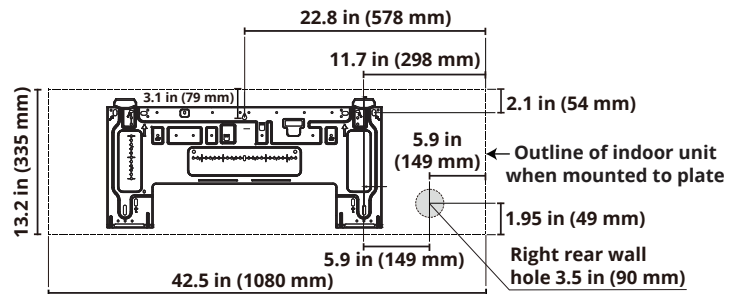

Series 18K & 24K Models

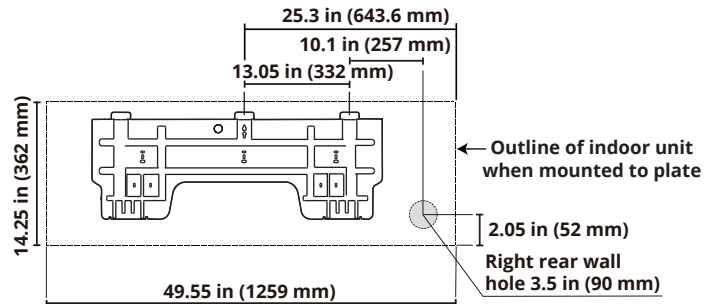

Series 36K Models

Fig. 4.5

## UNIT IS ADJUSTABLE

Keep in mind that the hooks on the mounting plate are smaller than the holes on the back of the unit. If you find that there is not enough room to connect embedded pipes to the indoor unit, it can be adjusted left or right by 1.25-1.95 in (30-50 mm), depending on the model.



Adjustment range of indoor unit to the left or right



## Step 4: Prepare indoor unit refrigerant piping

The piping of the indoor unit is attached to the back of the unit towards the bottom. It will be covered with insulation, and there will also be a drain pipe with these. This piping will need to be bent and prepared before it can be fed through the wall hole.

**NOTE: Refrigerant piping should exit the indoor unit from the right-hand side (Refer to Fig 4.6)**

1. Based on the position of the wall hole, relative to the mounting plate, determine the necessary angle the piping will need to be bent to pass through the wall hole when the unit is mounted to the bracket.
2. Grip the refrigerant piping at the base of the bend. Then, slowly, and with even pressure, bend the piping away from the back of the unit roughly 90 degrees. The piping should be sticking straight out from behind the unit once completed (Refer to Fig 4.6).

### ! CAUTION

Be extremely careful not to dent or damage the piping while bending it away from the unit, as this could negatively affect the performance.

Fig. 4.6

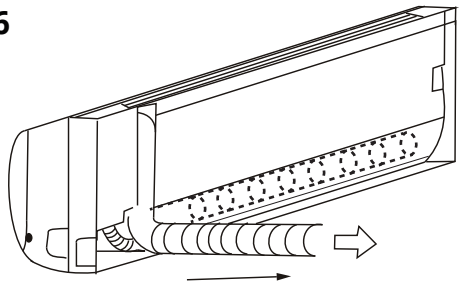

3. Now, you will need to lightly tape the refrigerant piping and drain pipe together in a bundle, using electrical tape, making sure that the drain pipe is at the bottom. **DO NOT** tape the ends of the piping (connectors). Refer to Fig 4.7 and the image below for the correct orientation of the piping when taping.

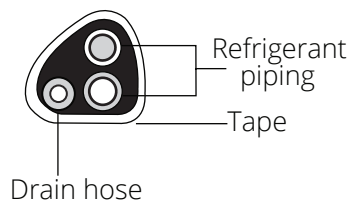

Fig. 4.7

### DRAIN HOSE MUST BE ON BOTTOM

The drain hose must be placed at the bottom of the bundle. If it is not, it could cause the drain pan to overflow, which could lead to fire or water damage.

## Step 5: Mount the Indoor Unit

In the following steps the indoor unit will now be mounted to the wall bracket and the piping and wires will be fed through the wall hole.

1. Double-check that the ends of the refrigerant pipes are sealed (screw on caps are still in place) to prevent any dirt or foreign material from entering the pipes.
2. Feed the MC Cable/signal wire (should be protected by conduit) through the wall hole.
3. Carefully lift the indoor air handler, and slowly feed the taped bundle of refrigerant pipes and drain hose through the wall hole, as you position it to mount to the wall bracket.

**NOTE: Positioning the air handler on to the wall bracket, while feeding the piping through the wall hole, might be difficult for a single person to manage. If so, it may be necessary to seek the assistance of another person for this step.**

4. Slightly lean the top of the air handler toward the wall and hook the top of the indoor unit on the upper hook of the wall mounting plate.
5. Check that the unit is hooked firmly on the mounting plate by applying slight pressure to the left and right-hand sides of the unit. The unit should not jiggle or shift.
6. Using even pressure, push down on the bottom half of the unit. Continue pushing down until the unit snaps onto the hooks along the bottom of the mounting plate.
7. Again, check that the unit is firmly mounted to the wall bracket by applying slight pressure to the left and right-hand sides of the unit.



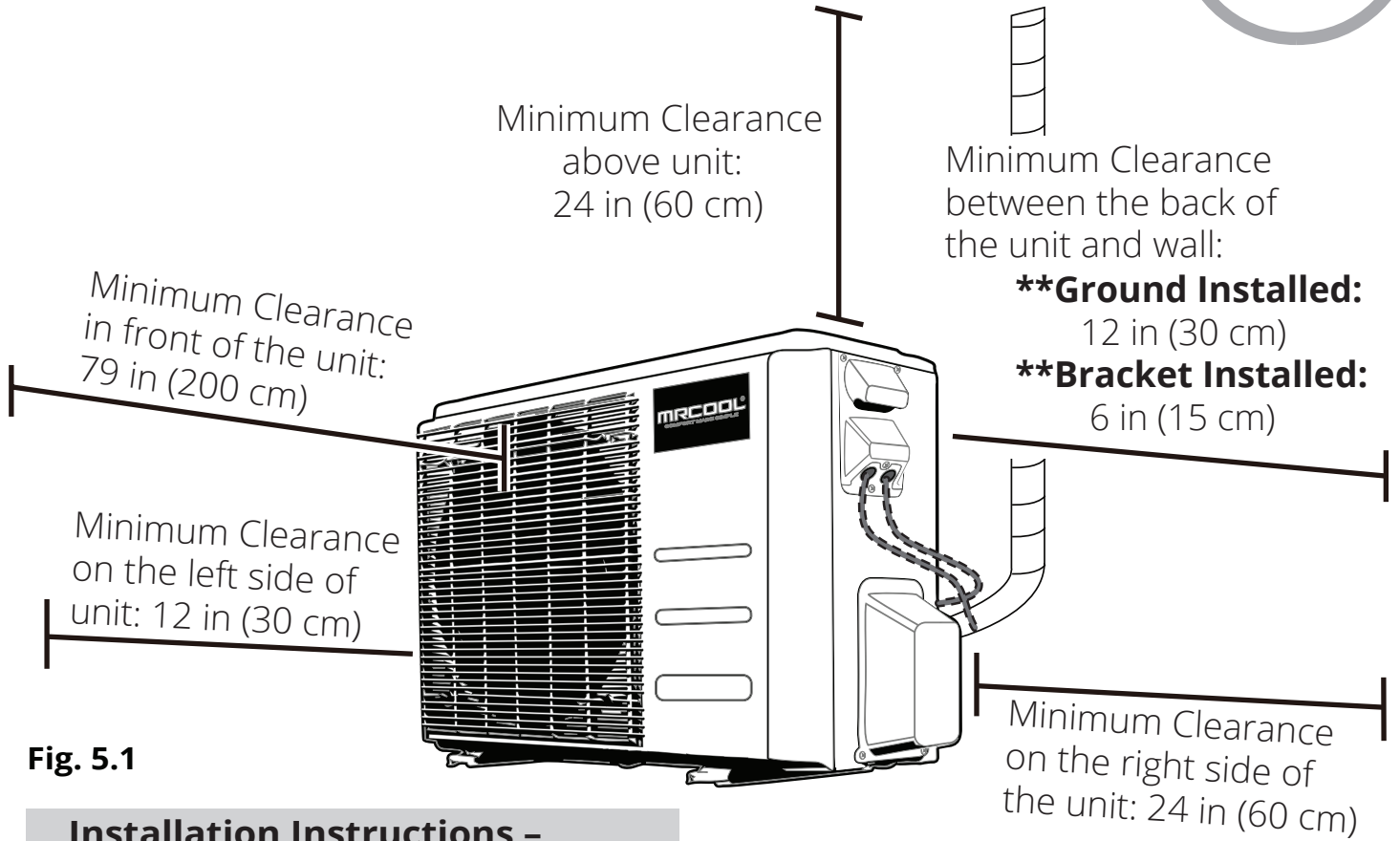

**Fig. 5.1**

## Installation Instructions - Outdoor Unit

### Step 1: Selecting an Installation Location

Before installing the outdoor unit, you must choose an appropriate location. Use the following guidelines to help you select an appropriate location.

**Proper installation locations should meet following guidelines:**

- ☑ Meets all spatial requirements shown in the illustration above (Fig. 5.1)
- ☑ Good air circulation and ventilation
- ☑ Firm and solid location that can support the unit and will not cause vibration
- ☑ Noise from the unit will not disturb others
- ☑ Protected from prolonged periods of exposure to direct sunlight or rain
- ☑ If installed in an area where snowfall is expected, take appropriate measures to prevent ice buildup and coil damage

**DO NOT install unit in the following locations:**

- ⊘ Near an obstacle that will block air inlets and outlets.
- ⊘ Near a public street, crowded areas, or where noise from the unit will disturb others.
- ⊘ Near animals or plants that could be harmed by hot air discharge.
- ⊘ Near any source of combustible gas.
- ⊘ In a location that is exposed to large amounts of dust.
- ⊘ In a location exposed to excessive amounts of salty air.
- ⊘ In a location that exposes the unit to large amounts of forced water.

# Outdoor Unit Installation

## SPECIAL CONSIDERATIONS FOR EXTREME WEATHER

**If the unit is exposed to heavy wind:** Install the unit so the air outlet fan is at a 90° angle to the direction of the wind. If needed, build a barrier in front of the unit to protect it from extremely heavy winds. Ensure the wind barrier does not block necessary airflow. See Fig. 5.2 and Fig. 5.3 below.

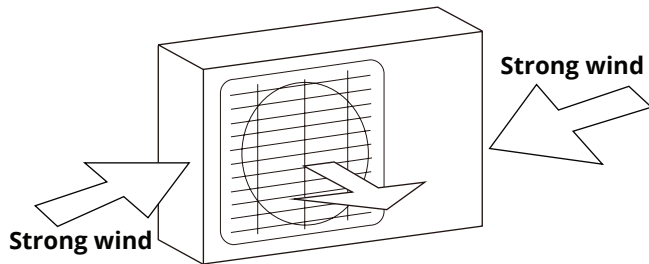

Fig. 5.2

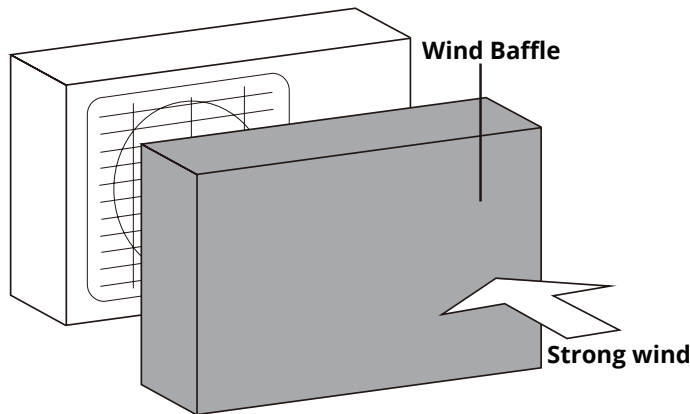

Fig. 5.3

**If the unit is frequently exposed to heavy rain or snow:** Build a shelter above the unit to protect it from the rain or snow. Be careful not to obstruct airflow around the unit.

**If the unit is frequently exposed to salty air (seaside):** Use an outdoor unit that is specially designed to resist corrosion.

### Step 2: Install drain joint

Heat pump units require a drain joint if the unit is elevated. Before bolting the outdoor unit in place, you must install the drain joint at the bottom of the unit. **NOTE: there are two different types of drain joints depending on the type of outdoor unit.**

**If the drain joint comes with a rubber seal (see Fig. 5.4 - A), do the following:**

1. Fit the rubber seal on the end of the drain joint that will connect to the outdoor unit.
2. Insert the drain joint into the hole in the base pan of the unit.
3. Rotate the drain joint 90° until it clicks in place facing the front of the unit.
4. Connect a drain hose extension (not included) to the drain joint to redirect water from the unit during heating mode.

**If the drain joint does not come with a rubber seal (see Fig. 5.4 - B), do the following:**

1. Insert the drain joint into the hole in the base pan of the unit. The drain joint will click in place.
2. Connect a drain hose extension (not included) to the drain joint to redirect water from the unit during heating mode.

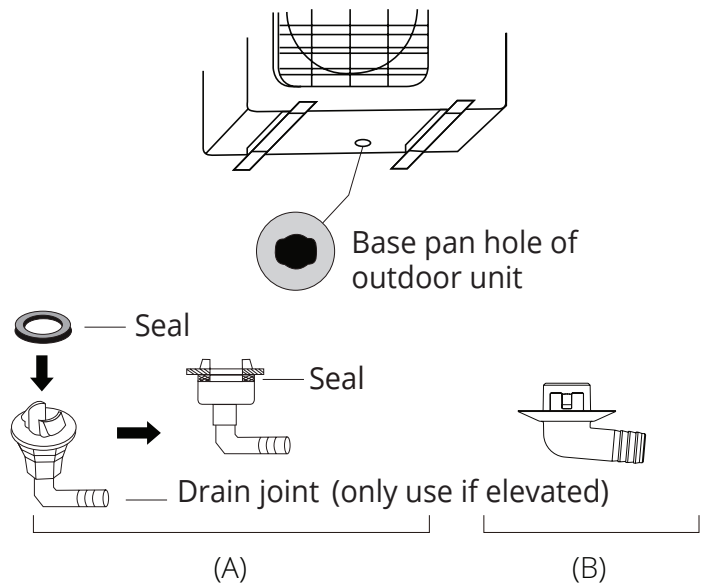

Fig. 5.4

## ! DRAINAGE IN COLD CLIMATES

In cold climates, make sure that the drain hose is as vertical as possible to ensure swift water drainage. If water drains too slowly, it can freeze.



# Outdoor Unit Installation

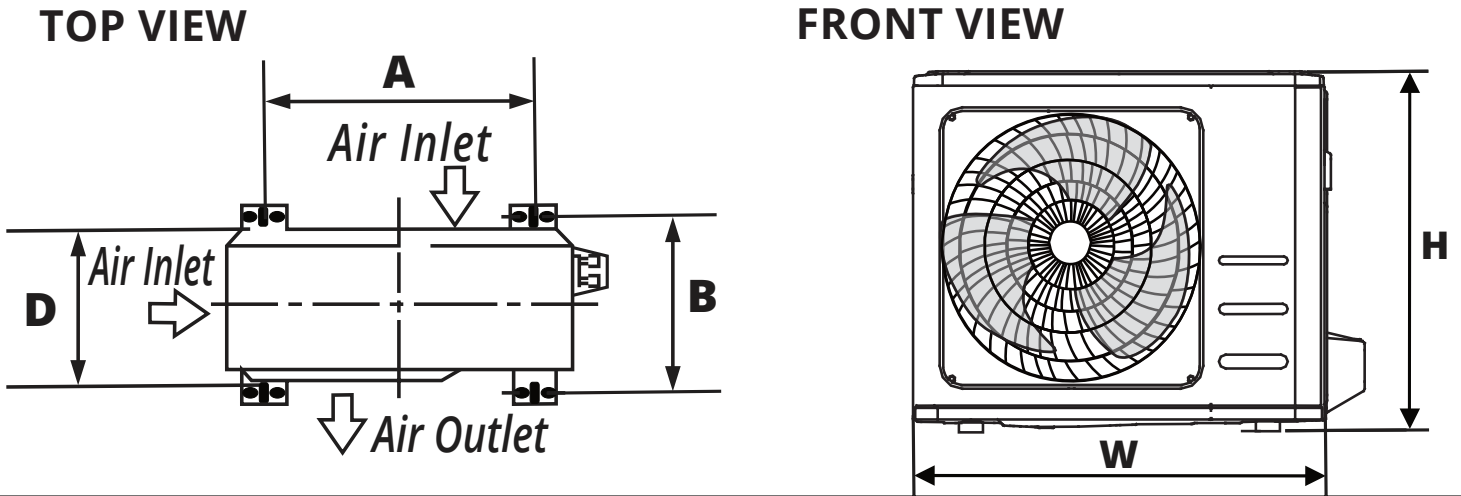

**Fig. 5.5**

### Step 3: Anchor Outdoor Unit

The outdoor unit can be anchored to the ground or to a wall-mounted bracket using M-10 bolts. Prepare the installation base of the unit according to the dimensions below. For instructions of how to mount the unit to a wall mounted bracket, please refer to the following page.

### UNIT MOUNTING DIMENSIONS

The following is a list of different outdoor unit sizes and the distance between their mounting feet. Prepare the installation base of the unit according to the dimensions in the table below, using the illustrations of the unit above (**Fig 5.5**) as a guide to correspond with the table.

|                  | Outdoor Unit Dimensions:<br>Inches (Millimeters) |  | Mounting Dimensions:<br>Inches (Millimeters) |                     |
|------------------|--|--|--|---------------------|
|                  | Width (W)  | Height (H) x Depth (D)                   | Width (A)                                    | Depth (B)           |
| DIY-12-HP-C-115C | 30.12 in<br>(765 mm)                             | 21.85 in x 11.93 in<br>(555 mm x 303 mm) | 17.8 in<br>(452 mm)                          | 11.3 in<br>(286 mm) |
| DIY-18-HP-C-230C | 35.04 in<br>(890 mm)                             | 26.50 in x 13.46 in<br>(673 mm x 342 mm) | 26.1 in<br>(663 mm)                          | 13.9 in<br>(354 mm) |
| DIY-24-HP-C-230C | 37.24 in<br>(946 mm)                             | 31.89 in x 16.14 in<br>(810 mm x 410 mm) | 26.5 in<br>(673 mm)                          | 15.9 in<br>(403 mm) |
| DIY-36-HP-C-230C | 37.24 in<br>(946 mm)                             | 31.89 in x 16.14 in<br>(810 mm x 410 mm) | 26.5 in<br>(673 mm)                          | 15.9 in<br>(403 mm) |

### If you are installing the outdoor unit on the ground, or a concrete mounting platform, use the following steps:

1. Mark the positions for four expansion bolts based on dimensions in the **Mounting Dimensions** chart and illustrations above.
2. Pre-drill holes for expansion bolts.
3. Clean concrete dust away from the holes.
4. Place a nut on the end of each expansion bolt.
5. Hammer expansion bolts into the pre-drilled holes.
6. Remove the nuts from the expansion bolts, and place outdoor unit on bolts.

7. Put a washer on each of the expansion bolts, then reinstall the nuts.
8. Using a wrench, tighten each nut until snug.

### **WARNING**

**WHEN DRILLING INTO CONCRETE, EYE PROTECTION IS RECOMMENDED AT ALL TIMES.**

**If you are installing the unit on a wall-mounted bracket, follow these steps:**

## **! CAUTION**

**Before installing a wall-mounted unit, make sure that the wall is made of solid brick, concrete, or a similarly strong material. The wall must be able to support at least 4 times the weight of the unit.**

1. Mark the position of the bracket holes based on the dimensions in the Mounting Dimensions chart on the previous page.
2. Pre-drill the holes for the expansion bolts.
3. Clean dust and debris away from the holes.
4. Place a washer and nut on the end of each expansion bolt.
5. Thread expansion bolts through the holes in the mounting brackets. Then, put the mounting brackets in position and hammer the expansion bolts into the wall.
6. Check that the mounting brackets are level.
7. If the feet of the outdoor unit have rubber pads already installed, and you're using a MRCOOL® wall-mounted bracket, remove them before attempting to mount the condenser to the bracket. The mounting bracket has rubber isolating pads on it that will take the place of these.
8. Carefully lift the unit and place its mounting feet on the brackets.
9. Then, bolt the unit firmly to the brackets.

## **TO REDUCE VIBRATION OF WALL-MOUNTED UNIT**

**If allowed, you can install the wall-mounted unit with rubber gaskets to reduce vibration and noise.**

## Step 1: Prepare exterior wall hole

Before the refrigerant piping can be installed and connected to the indoor and outdoor units, some additional steps are required to prepare the exterior.

1. Install finishing ring/cap to the exterior portion of the wall hole.



2. Place your hand on the underside of the piping coming through the exterior wall hole (from indoor unit), close to the wall. With your other hand, using even pressure, carefully bend the piping downward toward the wall, being mindful not to damage or dent the piping in the process.



### ! CAUTION

**Be extremely careful not to dent or damage the piping while bending it down the exterior wall, as this could negatively affect the performance.**

3. Pack the wall hole with the supplied Neoprene (or Spray Foam can be used) to seal the hole, filling any space that was not taken up by the refrigerant piping and lines.

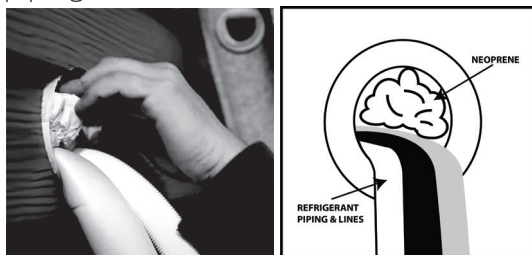

## Step 2: Unwind Quick Connect® Line Set to necessary length

1. Use your hands to slowly unwind the copper piping of one end of the Quick Connect® Line Set. The end you unwind will connect to the indoor unit piping. You should unwind the end until the connectors are close to flat on the ground (with little to no bend). If this is not done, it could make the line set difficult to maneuver when aligning the connectors with the air handler piping. Only unwind as much as necessary for your application, and allow any excess to remain coiled (**Refer to Fig. 6.1**).



### MINIMUM BEND RADIUS

When bending connective refrigerant piping, it needs to have a minimum bend radius of 4 inches (Refer to Fig 6.1).

### ! CAUTION

**If the pipe is repeatedly bent or extended, it will become hard and difficult to manipulate. Avoid bending or extending the pipe more than 3 times, or excessively, as it could break.**

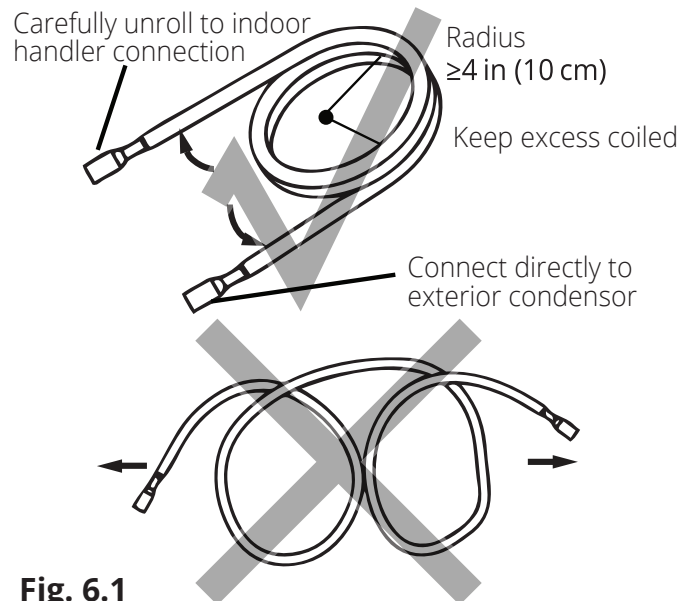

# Refrigerant Piping Connection

## Step 3: Connect Line Set to Indoor Unit

### 3.1 Tools needed

**NOTE:** Depending on the capacity rating of your unit, (12K, 18K, 24K, 36K) the wrench sizes needed will vary, refer to the table below (the unit uses metric sizes, the standard sizes listed are approximations). Based on the availability of wrenches in some of the sizes needed, the recommended method is to use crescent wrenches that can be adjusted to fit the size each step requires.

- Opened-ended wrench sizes needed (1x of each of these)

| 12K & 18K      | 24K & 36K      |
|----------------|----------------|
| 3/4" / 19 mm   | 3/4" / 19 mm   |
| 7/8" / 22 mm   | 15/16" / 24 mm |
| 15/16" / 24 mm | 1" / 26 mm     |
| 1" / 26 mm     | 1-1/8" / 29 mm |
|                | 1-1/4" / 31 mm |

Or 2x Crescent (adjustable-type) Wrenches

- 1x HVAC Torque Wrench (if available)
- 1x Allen key, 5 mm
- 1x Phillips-head screwdriver
- 1x leak-detection spray or a soapy water solution (liquid detergent/mix, applied by brush or spray bottle)

### 3.2 IMPORTANT INFORMATION

#### PLEASE READ FULLY BEFORE PROCEEDING TO NEXT STEP

- Follow the detailed instructions for connecting the line set to the indoor unit and outdoor units. We can only provide a warranty if the line set is installed correctly as described in the instructions.
- To prevent leaks, ensure that the Quick Connect® connectors are free of dirt. Moisture or foreign bodies will adversely affect the function of the connectors and could lead to a risk of refrigerant loss (not covered by the warranty).
- Only install the line set outdoors in dry weather.
- The line set must not be plastered over after being installed.
- Always wear work gloves and goggles and use caution when handling refrigerant. Please make sure that refrigerant is never allowed to enter the environment. Improper handling of refrigerant may be harmful to your health.
- The equipment must never be operated without the line set connected, otherwise the equipment will be damaged immediately.
- Quick Connect® line set connections must only be tightened using the appropriate open-ended or crescent (adjustable-type) wrenches.

⚠ **DO NOT** remove the sealing caps and stoppers from the line set or valves until immediately before they are to be connected.

⚠ **DO NOT** smoke during the installation.

### Refrigerant Pipe Connectors (both ends):

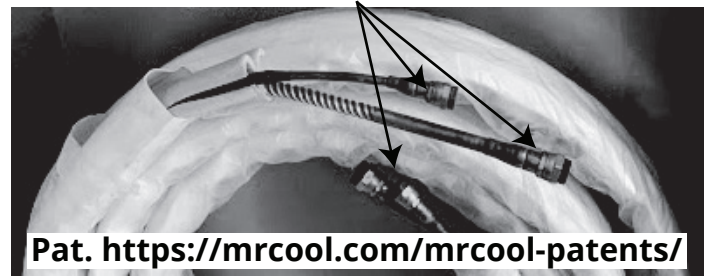

If the screw connections are tightened with too little torque, they will leak. If they are tightened with too much torque, the screw connections could suffer damage. Please refer to the torque requirements section for more information. If you do not feel confident connecting the line set connectors yourself, it is imperative that you contact the MRCOOL® customer service team or an HVAC professional.

#### IMPORTANT:

The line sets are designed to only be installed once. The seal within the line set cannot be guaranteed if they are installed more than once. This will void the warranty. They also contain a compression fitting to seal and do not require a thread sealant (Teflon tape, etc.). Using a sealant may actually cause the connection to leak over time.

### 3.3 Connecting the Quick Connect® Line Set to the piping from indoor unit

1. Do not remove the plastic seals of the piping coming from the indoor unit, or the appropriate line set connector, until immediately before they are to be connected. The plastic seals on each of the connectors should be color-coded to match the seals of the corresponding pipes they are to be connected to.
2. Align the refrigerant pipes correctly, making sure the dimensions of the connecting refrigerant pipe match. Unscrew the seals and place the screw connector of the line set just onto the threads of the piping from the indoor unit and tighten the first few threads by hands.

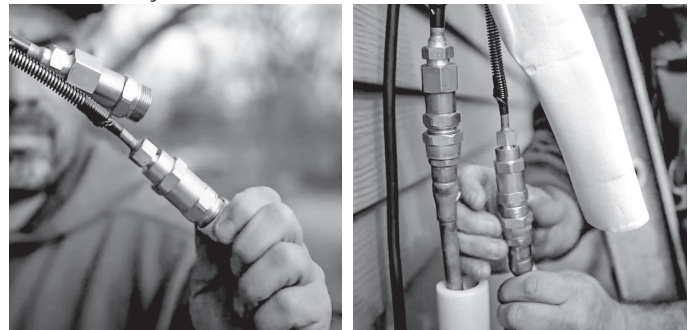

#### IMPORTANT:

Before you continue, it is essential that you read the following instructions fully and carefully.



## ! TORQUE REQUIREMENTS

1. Excessive force can break the connector or damage the refrigerant piping. You must not exceed the torque requirements shown in the table below.
2. You can find the Outer Pipe Diameter stamped (in inches) on the valve set of the condenser. Refer to this when finding and applying the torque values in the table below.
3. Please note that there may be differences in Torque Wrenches (i.e. automotive torque wrench versus an HVAC torque wrench) and that a socket style wrench cannot be used in this installation.

**NOTE:** Torque ratings in the table below are to be used if you have access to an HVAC torque wrench. These are available for purchase from online retailers. However, it is possible to complete installation of refrigerant line sets with conventional open-ended/crescent wrenches. It is imperative, however, that you not overtighten the connector, and that once the lines have been fully connected, you follow the steps to check for leaks. If you do not feel comfortable attempting this, please contact a qualified HVAC technician.

3. Using the image below as a guide, and the steps outlined in this paragraph, you will now tighten the nuts of the screw connectors of the Quick Connect® line set to the indoor unit. Using two appropriate sized open-ended wrenches (depending on the dimensions of the connector) or adjustable crescent wrenches, place one of the wrenches on the nut marked "1", and the other wrench on the nut marked "2," as shown in the image below. Now, turn the wrench marked "2" in the direction of the rotational arrows, as shown, while holding the other wrench in place. Continue to tighten the connector until snug. **NOTE: work quickly and make sure the screw connectors do not become crooked as you tighten them.**

**\* If an HVAC torque wrench is available:** Once the connector is snug, using the torque wrench, tighten the connector to the specified torque rating, as listed in the table to the right (based on pipe/coupling size).

**\* If an HVAC torque wrench is NOT available:** Using two wrenches you used to tighten the connector, once the connector is snug, turn the wrench slightly beyond that point to torque the connector, but do not overtighten it.

4. Repeat the same process for the second line.

| Stamp (on coupler) | Coupling Size inch (millimeter) | Tightening Torque lb-ft (N-m) |
|--------------------|---------------------------------|-------------------------------|
| FA06               | 3/8 in (9.5 mm)                 | 18-20 lb/ft (24.4-27.1 Nm)    |
| FA09               | 1/2 in (12.7 mm)                | 30-35 lb/ft (40.6-47.4 Nm)    |
| FA12               | 3/4 in (19.1 mm)                | 45-50 lb/ft (61.0-67.7 Nm)    |
| FA16               | 1 in (25.4 mm)                  | 60-65 lb/ft (81.3-88.1 Nm)    |

**Note:** Coupler stamp reads "FA". Line Set stamp reads "FB".

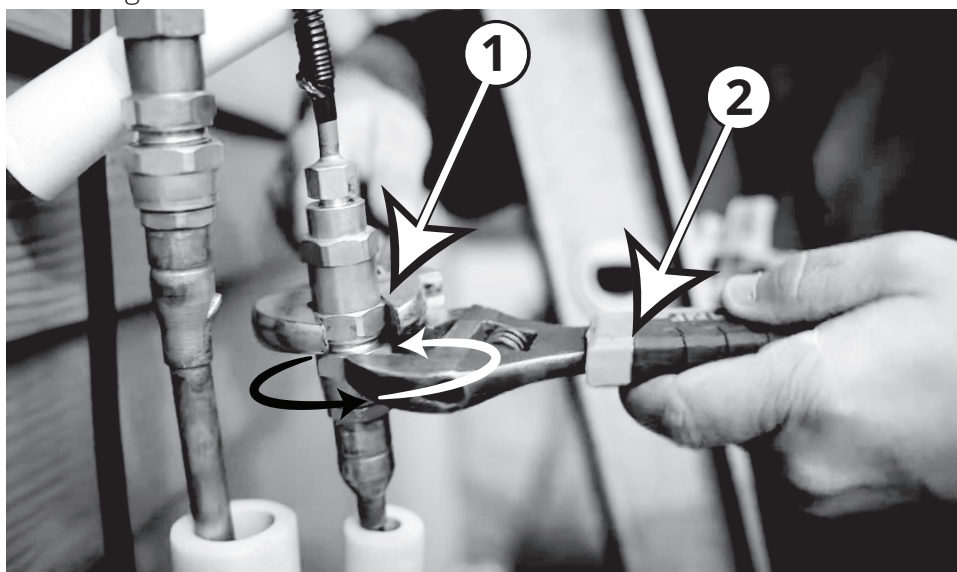

## **!** CAUTION

For your safety, always wear goggles and work gloves when connecting the pipes.

### Step 4: Connect Line Set to the Outdoor Unit

1. First remove the water tray on the outdoor unit as shown in the illustration to the right.

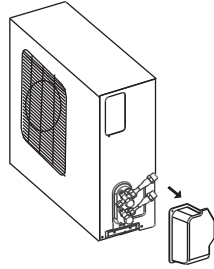

2. Do not remove the plastic seals from the outdoor unit piping connectors and corresponding refrigerant pipes (line set to be attached) until immediately before you connect them.

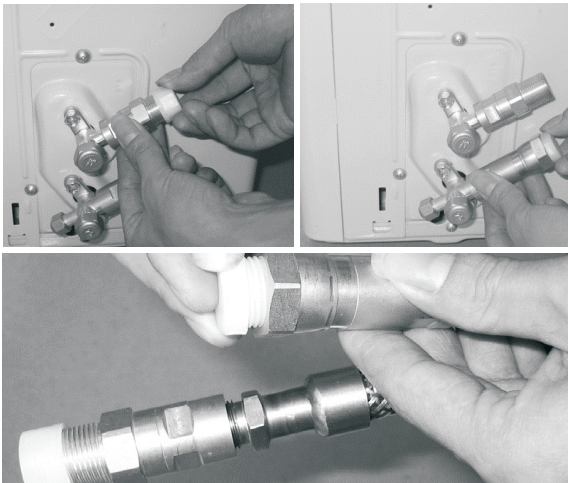

**NOTE: Ensure the adapters attached to the outdoor valves have been tightened properly before attempting to connect the line set.**

3. Align the refrigerant pipes so they line up with the corresponding valves and have enough slack. **NOTE: The refrigerant pipes must be connected to the valves with as little stress as possible.** Unscrew the plastic seals and place the screw connector of the refrigerant line just onto the threads of the outdoor unit, tightening the first few threads by hand.

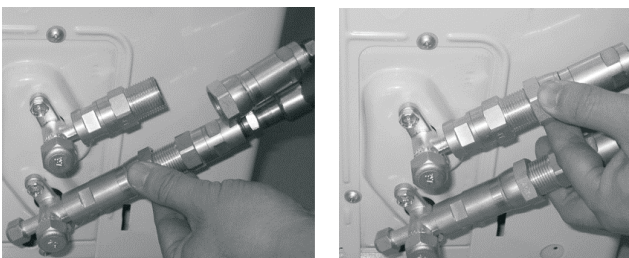

### IMPORTANT:

Before you continue, it is essential that you read the following instructions carefully.

4. Using the first image below as a guide, starting with the bottom screw connector, you will now tighten the line set to the outdoor unit. Using two appropriate sized open-ended wrenches (depending on the dimensions of the connector), or adjustable crescent wrenches, place one of the wrenches on the nut marked "1," and the other wrench on the nut marked "2." Now, turn the wrench on nut "2" in the direction of the rotational arrow, while holding the other wrench in place, as seen in the first image below. Continue to tighten the connector until snug. **NOTE: work quickly and make sure the screw connectors do not become crooked as you tighten them.**

**\*If an HVAC torque wrench is available:** Once the connector is snug, using the torque wrench, tighten the connector to the specified torque rating, listed in the table on the next page (based on the pipe/coupling size).

**\*If an HVAC torque wrench is NOT available:** Using the two wrenches you used to tighten the connector, once the connector is snug, then turn the wrench slightly beyond that point to torque the connector, but do not overtighten it.

5. Repeat the same process for the top screw connector, using the second image below as a guide.

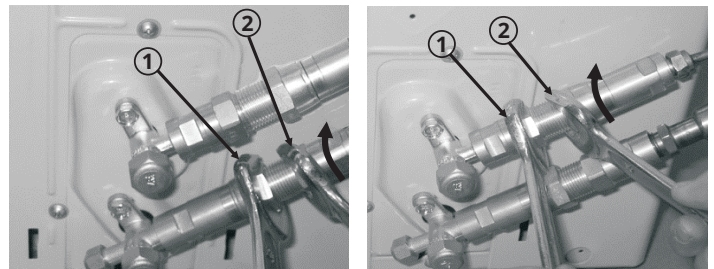

## **!** IMPORTANT

The coupling of the outdoor unit uses tapping rings, if you disconnect and reconnect the refrigerant pipes, it could cause it to leak. This will also void the warranty.

### NOTE:

Keep excess refrigerant hose coiled. Wrap with protective tape and store behind the condenser in a horizontal position (flat with the ground).

## TORQUE REQUIREMENTS

1. Excessive force can break the connector or damage the refrigerant piping. You must not exceed the torque requirements shown in the table below.
2. You can find the Outer Pipe Diameter stamped (in inches) on the valve set of the condenser. Refer to this when finding and applying the torque values in the table below.
3. Please note that there may be differences in Torque Wrenches (i.e. automotive torque wrench versus an HVAC torque wrench) and that a socket style wrench cannot be used in this installation.

**NOTE: Torque ratings in the table below are to be used if you have access to an HVAC torque wrench. These are available for purchase from online retailers. However, it is possible to complete installation of refrigerant line sets with conventional open-ended/crescent wrenches. It is imperative, however, that you not over-tighten the connector, and that once the lines have been fully connected, you follow the steps to check the pipe connections for leaks (Refer to the Electrical & Gas Leak Checks section of this manual for more information). If you do not feel comfortable attempting this, please contact a qualified HVAC technician.**

| Stamp<br>(on<br>connector) | Coupling Size<br>inch (millimeter) | Tightening Torque<br>lb-ft (N-m) |
|----------------------------|------------------------------------|----------------------------------|
| FA06                       | 3/8 in (9.5 mm)                    | 18-20 lb/ft<br>(24.4-27.1 Nm)    |
| FA09                       | 1/2 in (12.7 mm)                   | 30-35 lb/ft<br>(40.6-47.4 Nm)    |
| FA12                       | 3/4 in (19.1 mm)                   | 45-50 lb/ft<br>(61.0-67.7 Nm)    |
| FA16                       | 1 in (25.4 mm)                     | 60-65 lb/ft<br>(81.3-88.1 Nm)    |



# Refrigerant Piping Connection

## Step 5: Opening the refrigerant valves of the outdoor unit

1. Using the images below as a guide, remove the cover on the top valve, using a 19 mm open-ended wrench or a crescent (adjustable-type) wrench. Then, insert a 5 mm Allen key and open the valve by turning it counter-clockwise as far as it will go. **DO NOT force it.** The valve is now open. Screw the cover back onto the top valve and tighten it well to ensure that it is properly sealed.
2. Using the images below as a guide, repeat the same process for the bottom valve. Remove the cover on the bottom valve, using a 19 mm open-ended wrench or a crescent (adjustable-type) wrench. Then, insert a 5 mm Allen key and open the valve by turning it counter-clockwise as far as it will go. **DO NOT force it.** Screw the cover back onto the bottom valve and tighten it well to ensure that it is properly sealed.

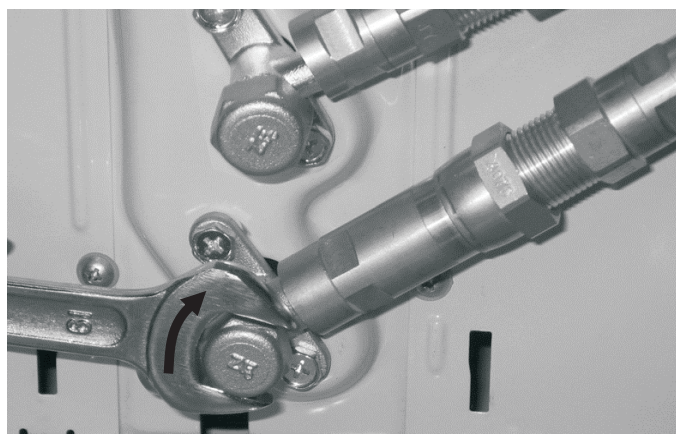
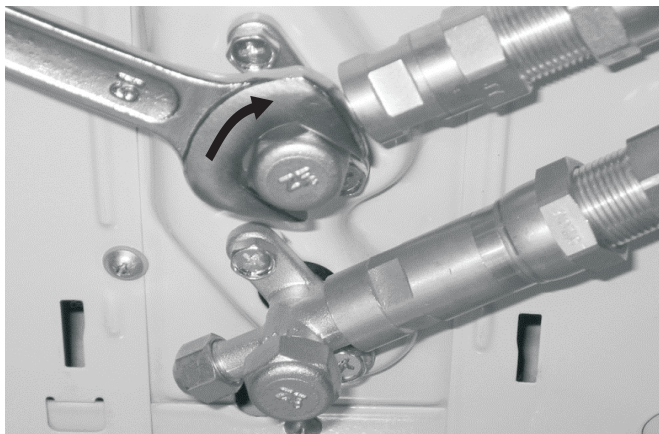
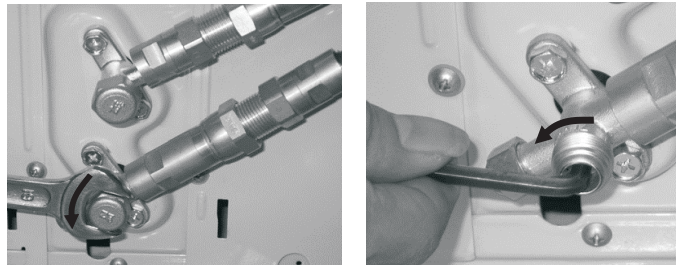
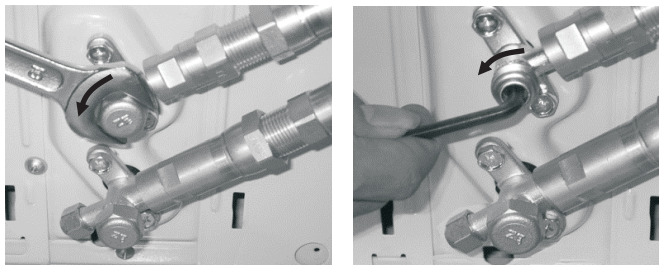

### ! CAUTION

If the valves are not fully opened, it could cause the system to malfunction and suffer damage.

3. After completing steps 1 and 2, you will now need to check all of the piping connections (at indoor unit and outdoor unit) for leaks. You can do this by using leak detection spray, or applying a soapy water solution (liquid detergent/water mixture) to the connection via a spray bottle or brush. If any bubbles begin to form, that indicates there is a leak, and the connection needs to be re-tightened. Tighten the connection and recheck it for leaks. Refer to **Electrical and Gas Leaks Checks** section of this manual for more information.



### IMPORTANT:

You will be asked to check for leaks at the piping connections multiple times throughout the following steps of the installation, because the pressures within the lines will change once the unit is turned on and this could reveal leaks not present during the initial check. These are imperative to make sure your connections are not allowing refrigerant to escape the system. When checking for leaks, if any bubbles form, it indicates the system has a leak and the screw connector needs to be re-tightened. For more information about checking for leaks, please refer to the **Electrical and Gas Leak Checks** section of the manual.

# Refrigerant Piping Connection

## Step 6: Wrap Piping Connections

In this step you will wrap and insulate the exposed line connections coming from the indoor air handler.

### IMPORTANT

**Do not complete these steps until all of the refrigerant piping connections have been checked for leaks.**

1. Wrap the connectors at the indoor air handler tightly with the supplied sound deadening pads.



2. Now, place the supplied insulation material over the connectors and exposed refrigerant piping

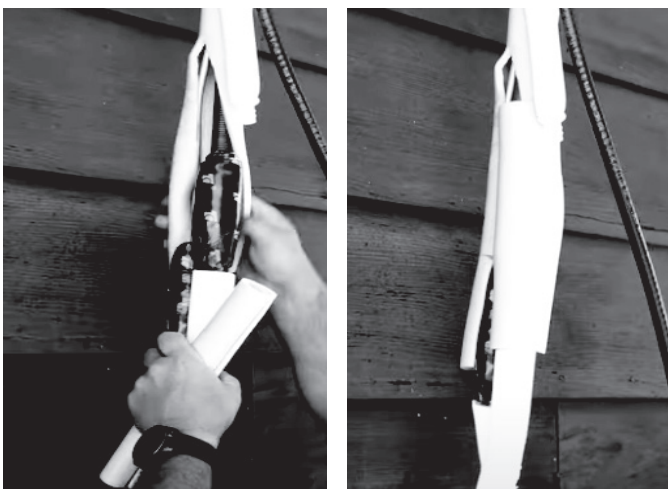

3. Now, starting where the line set is not covered with the factory plastic (close to the indoor air handler connection), you will wrap the line set upward to the wall hole, using the supplied Non-adhesive U.V. tape. This will cover the insulated line set connections, cables, and drain hose. The drain pipe will need to be at the bottom of the bundle (**Refer to Fig. 6.2**).

⚠ **DO NOT** wrap the end of the drain hose.

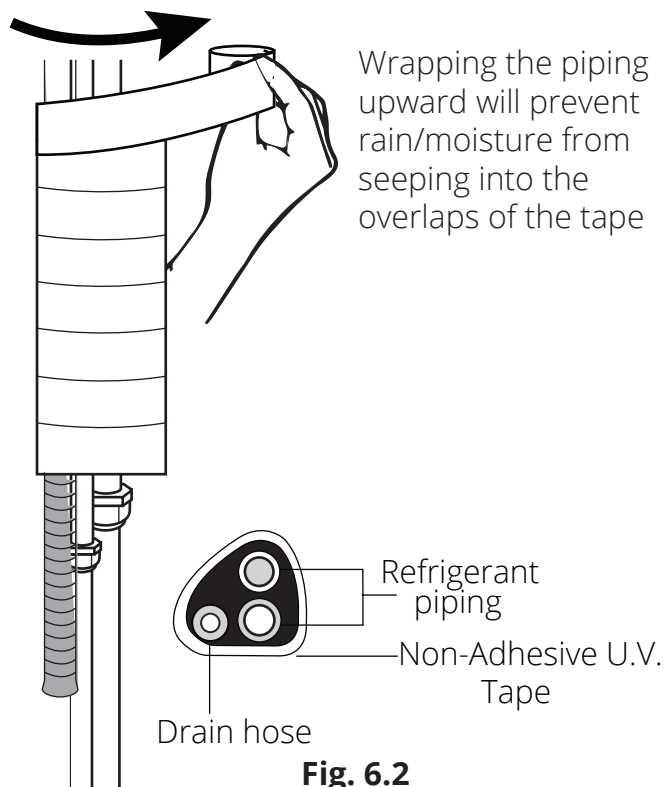
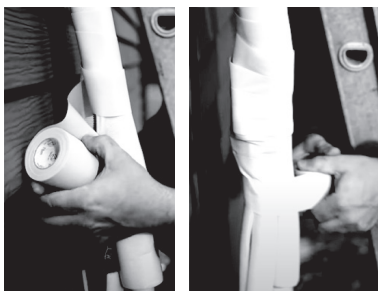

If you would like the exterior piping on the side of your home to have a sleeker, more attractive look and add some extra protection in the process, you can purchase a **MRCOOL® LineGuard® Line Set Cover**. This will encase your refrigerant piping and lines, protecting them from harsh weather conditions and sun exposure, which will extend the life of your system. These covers are available in various sizes to fit your particular application.



# Refrigerant Piping Connection

## Step 7: Connect Drain Pipe

In this step you will connect the drain hose extension to the drain hose exiting from the indoor unit that is within the piping bundle you wrapped in the previous steps.

1. Securely connect the drain hose extension to the drain piping from the indoor unit.



2. Using example **Fig. 6.3a** as a guide, make sure your drain pipe is run in a similar manner. The other examples in **Fig 6.3** represent things you should avoid when installing your drain pipe.
3. Remove the air filter from the indoor unit and pour a small amount of water into the drain pan to ensure that the water exits the bottom of the unit and flows through the drain and drain pipe smoothly.

### NOTE ON DRAIN HOSE PLACEMENT

#### ! CAUTION

Make sure to arrange the drain hose correctly according to Fig. 6.3a.

- ⊘ **DO NOT** kink the drain hose.
- ⊘ **DO NOT** create a water trap.
- ⊘ **DO NOT** put the end of the drain hose in water or a container that will collect water.

#### ENSURE UNUSED DRAIN HOLE IS PLUGGED

To prevent unwanted leaks, be sure that the factory installed hollow center rubber plug is installed in the unused drain hole.

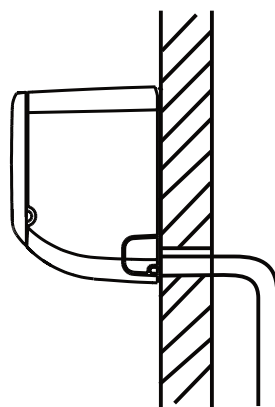

Fig. 6.3a

Make sure there are **NO** kinks or dents in the hose to ensure proper drainage.

**NOT CORRECT**  
**KINKS** in the drain hose will create water traps.

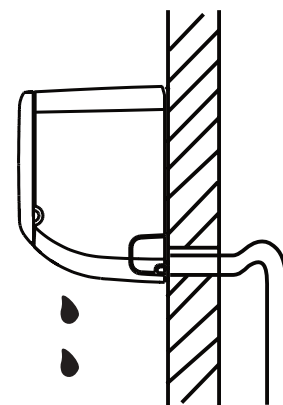
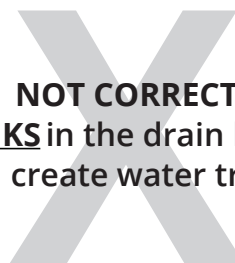

Fig. 6.3b

**NOT CORRECT**  
**DENTS** in the drain hose will create water traps.

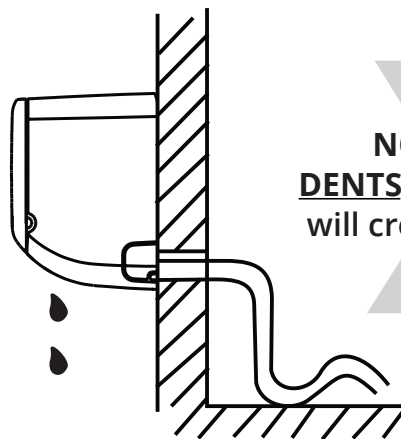

Fig. 6.3c

**NOT CORRECT**  
**DO NOT** place the end of the drain hose in water or in containers that collect water. This will prevent proper drainage.

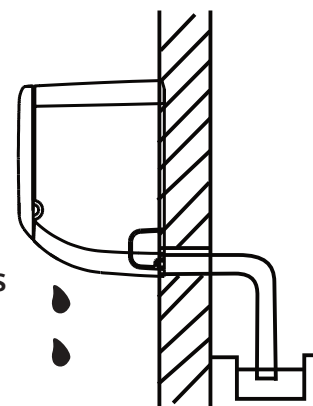
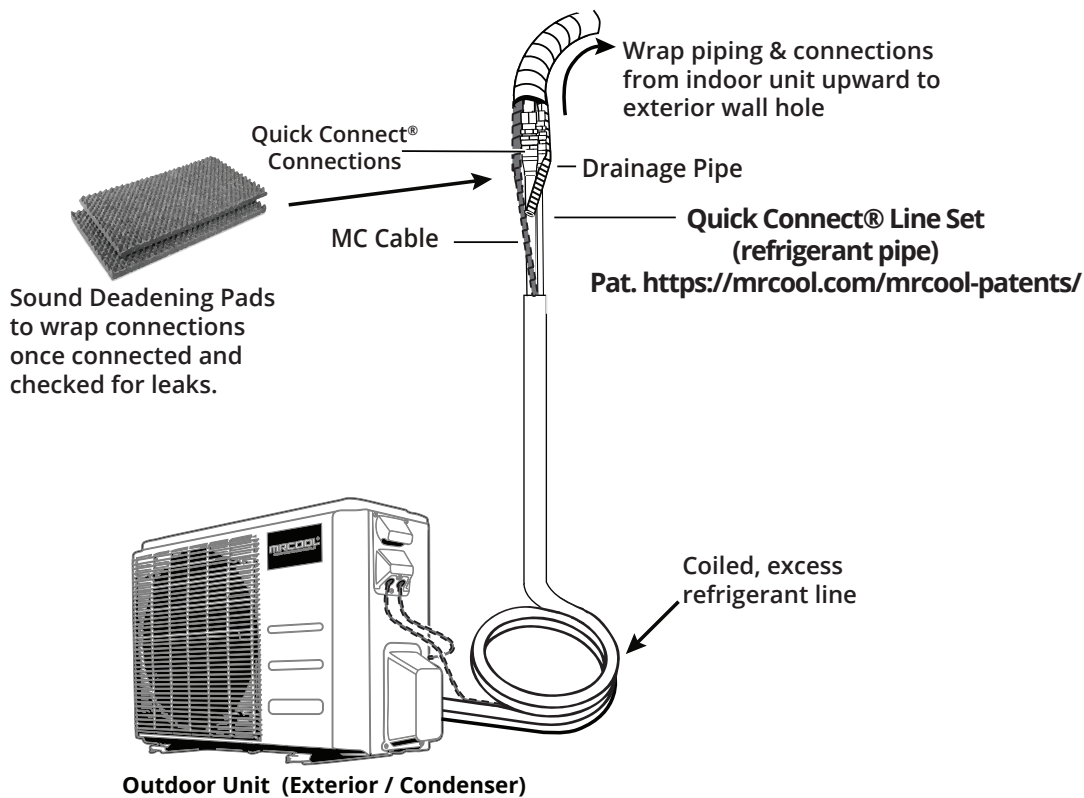

Fig. 6.3d



# Refrigerant Piping Connection



## BEFORE PERFORMING ELECTRICAL WORK, READ THESE REGULATIONS

- ⊘ **DO NOT** connect another appliance to the outlet for the unit. Only connect the unit to an individual branch circuit outlet.
  - ⊘ **DO NOT** allow wires to touch or rest against the refrigerant piping, compressor, or any other moving parts within the unit.
1. All wiring must comply with local and national electrical codes, regulations, and must be installed by a licensed electrician.
  2. All electrical connections must be made according to the Electrical Connection Diagram located on the panels of the indoor and outdoor units.
  3. If there is a serious safety issue with the power supply, stop work immediately. Explain the issue to the client, and refuse to continue the installation until the safety issue is properly resolved.
  4. Power voltage should be within 90-110% of the rated voltage. An insufficient power supply can cause a malfunction, electrical shock, and/or fire.
  5. If connecting power to fixed wiring, a surge protector and main power switch should be installed.
  6. The circuit, including any switches, should have a capacity 1.5 times the maximum unit current (amps).
  7. A qualified technician must use an approved circuit breaker or switch that disconnects all poles and has a contact separation of at least 1/8 in (3 mm) incorporated in the fixed wiring.
  8. Make sure the unit/system is properly grounded.
  9. Every wire must be firmly and securely connected. Loose wiring can cause the terminal to overheat, which could result in a malfunction and/or fire.
  10. If the unit has an auxiliary electric heater, it must be installed as least 40 in (1 m) away from combustible materials.
  11. To avoid electrical shock, never touch the electrical components soon after the power supply has been turned off. Always wait 10 minutes or more before touching the electrical components once the power has been turned off.

## Connect the MC Cable/signal wire and power cable

**NOTE:** The outside unit's terminal block is protected by an electrical wiring cover on the side of the unit. A comprehensive wiring diagram is printed on the inside of the wiring cover.

### **WARNING**

**\*\*\*BEFORE PERFORMING ANY ELECTRICAL WORK, TURN OFF ALL POWER TO THE SYSTEM.\*\*\***

Note that the wire colors of this series/model may differ from previous models, other series and general wiring conventions. All wiring must be performed in accordance with the wiring diagrams shown in Fig. 7.1 and demonstrated in the images below.

#### WIRE CONNECTING DIAGRAM (12K Unit Only)

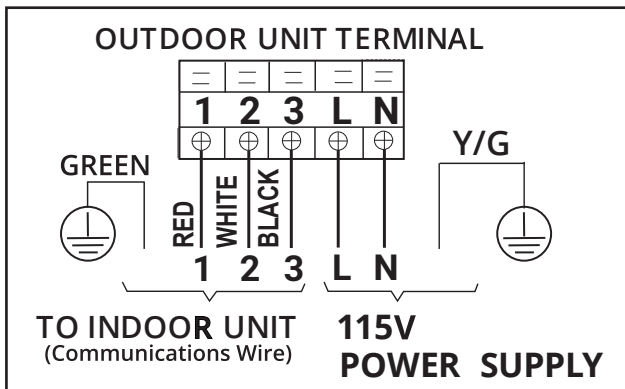

#### WIRE CONNECTING DIAGRAM (All other units)

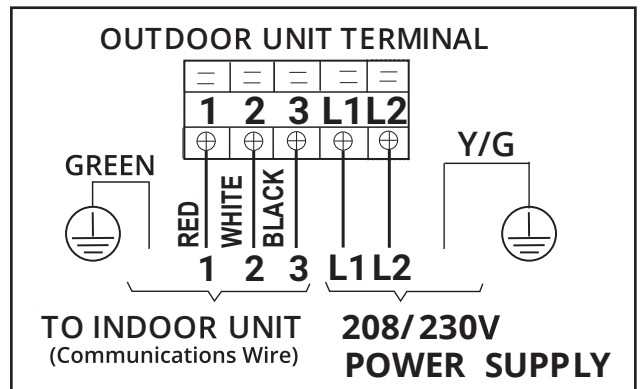

Fig. 7.1

### **WARNING**

**DO NOT MIX UP LIVE AND NULL WIRES.**

- This is dangerous and could cause the unit to malfunction. Make sure you clearly distinguish the live ("L") wires from the other wires.
- All wiring must be performed in accordance with the wiring diagrams shown in Fig. 7.1 and demonstrated in the images shown here.

**WIRES AND TERMINALS ARE NUMBERED TO CORRESPOND WITH ONE ANOTHER AS SHOWN BELOW.**

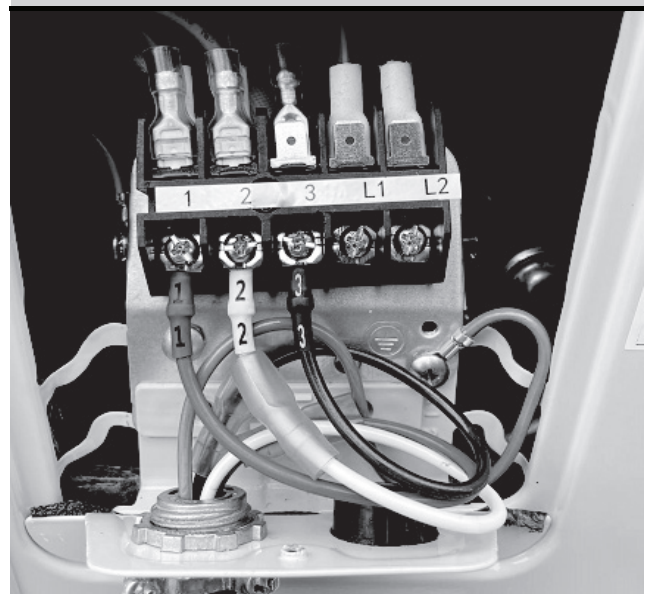

# Electrical Connections

1. Remove the screws from the electrical wiring cover from the outdoor condenser, as shown in the image below and **Fig.7.2**, and remove it.



2. Remove the retaining nut from the end MC cable that you fed through the wall hole earlier in the installation, as shown in the image below.



3. Now, pull the end of the MC cable through the hole of the electrical cover you removed earlier. Please refer to the images below.

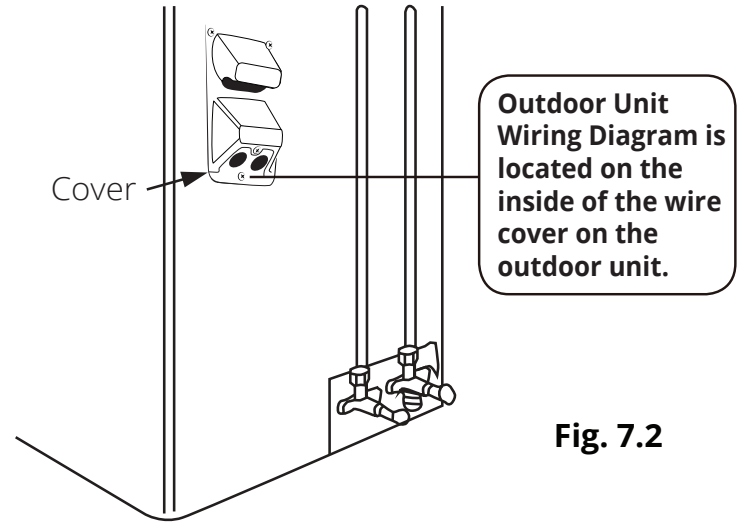

**Fig. 7.2**

## SELECT THE CORRECT CABLE

- See table below for gauge requirements

**NOTE:** The table below is a standard chart, the AWG ratings and wiring needs will change based on wire length and temperature.

### Minimum Wire Gauge for Power Cables

| Model Series | Appliance Amps (A) |     | AWG  |       |
|--------------|--------------------|-----|------|-------|
|              | MCA                | MOP | Min. | Pref. |
| 9K & 12K     | 19                 | 25  | 12   | 10    |
| 18K          | 18                 | 30  | 10   | 8     |
| 24K          | 22                 | 35  | 8    | 6     |
| 36K          | 28                 | 35  | 8    | 6     |

## WARNING

**ALL WIRING MUST BE INSTALLED STRICTLY IN ACCORDANCE WITH THE WIRING DIAGRAM LOCATED AS SHOWN IN FIG. 7.2.**

## NOTE ABOUT FUSE SPECIFICATIONS

The air conditioner's circuit board (PCB) is designed with a fuse to provide overcurrent protection. The specifications of the fuse are printed on the circuit board.

**EXAMPLE (Indoor Unit):** T3.15AL/250VAC, T5AL/250VAC, T3.15A/250VAC, T5A/250VAC, etc.

**EXAMPLE (Outdoor Unit):**  
T20A/250VAC (<=18,000 Btu/h units),  
T30A/250VAC (>18,000 Btu/h units), etc.

# Electrical Connections

- Now, secure the MC cable to the electrical cover by pushing the threaded end of the cable into the hole and reinstalling the retaining nut previously removed onto the end of the cable. Please refer to the images below.

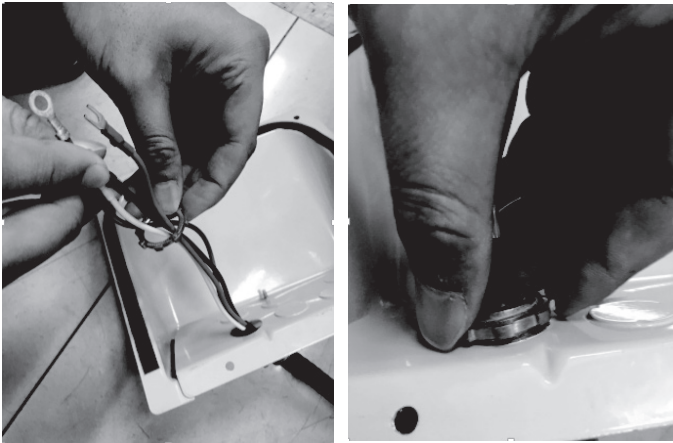

- Finally, reinstall the electrical wiring cover and secure it using by reinstalling the screws you previously removed.



- Then, you will connect the wires to the terminal block. Each wire should be numbered and correspond with a connection port on the terminal block. Match up each wire with the correct port, and firmly screw the u-lug of each wire to its corresponding terminal. Now, screw the ground wire into the bottom screw of the terminal block, as shown in the image below.

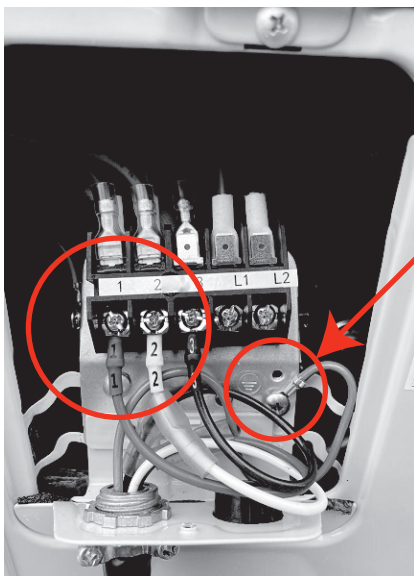

**Ground wire Connection**



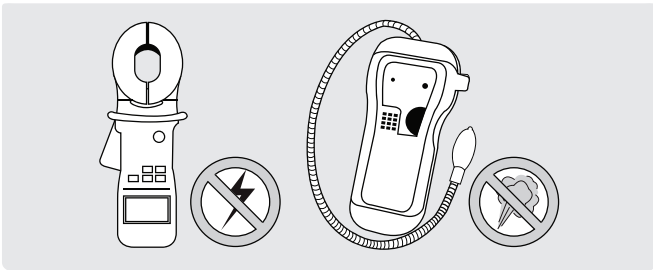

## WARNING – RISK OF ELECTRICAL SHOCK

**ALL WIRING MUST BE INSTALLED BY A LICENSED ELECTRICIAN AND COMPLY WITH LOCAL, STATE, AND NATIONAL ELECTRICAL CODES.**

### Electrical Safety Checks

After installation is complete, confirm that all electrical wiring has been installed in accordance with local and national regulations, and according to the installation manual.

#### BEFORE TEST RUN

#### Check Grounding Work

Measure grounding resistance by visual detection and with a grounding resistance tester. Grounding resistance must be less than 0.1Ω.

**NOTE: This may not be required for some locations in North America.**

#### DURING TEST RUN

#### Check for Electrical Leakage

During the Test Run, use an electroprobe and multimeter to perform a comprehensive electrical leakage test.

#### IF ELECTRICAL LEAKAGE IS DETECTED

**If electrical leakage is detected, turn off the unit immediately and call a licensed electrician to find and resolve the cause of the leakage.**

**NOTE: This may not be required for some locations in North America.**

### Gas Leak Checks

There are two different methods to check for gaseous leaks. Use **Fig. 8.1** below as a guide for the critical points to check for leaks.

#### Soap and Water Method

Using a soft brush or spray bottle, apply a soapy water solution to all of the pipe connection points of the indoor and outdoor units, watching to see if any bubbles form. The presence of bubbles indicates there is a leak.

#### Leak Detector Method

If using a leak detector, refer to the device's operation/instruction manual for proper usage instructions.

#### AFTER PERFORMING GAS LEAK CHECKS

**After confirming that all of the refrigerant pipe connections points *DO NOT* leak, replace the valve cover on the outside unit and wrap and insulate the piping connections of the indoor unit.**

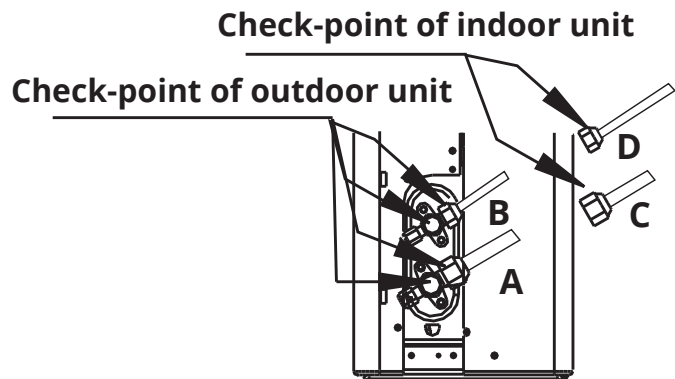

**A: Low pressure stop valve  
B: High pressure stop valve  
C & D: Indoor unit flare nuts**

**Fig. 8.1**

## Before Test Run

Only perform test run after you have completed the following steps:

- **Electrical Safety Checks** - Confirm that the unit's electrical system is safe and operating properly.
- **Gas Leak Checks** - Check all refrigerant piping/line set connections and confirm that the system is not leaking.
- Confirm that the gas and liquid (high and low pressure) stop valves are fully open. **If the valves are not fully opened before the system is turned on, damage could occur.**

## Test Run Instructions

You should perform the Test Run for at least 30 minutes.

1. Connect power to the unit.
2. Press the **ON/OFF** button on the remote controller to turn on the system.
3. Press the **MODE** button to scroll through the following functions, one at a time:
  - **COOL** - Select the lowest possible temperature
  - **HEAT** - Select the highest possible temperature
4. Let each function run for 5 minutes and then perform the checks listed in the table to the right.

| List of Checks to Perform                                   | PASS/FAIL    |             |
|---|--------------|-------------|
| No electrical leakage                                       |              |             |
| Unit is properly grounded                                   |              |             |
| All electrical terminals properly covered                   |              |             |
| Indoor and outdoor units are solidly installed              |              |             |
| Wall Hole Sleeve is packed airtight                         |              |             |
| All refrigerant piping connection points <b>DO NOT</b> leak | Outdoor (2): | Indoor (2): |
| Water drains properly from drain pipe                       |              |             |
| All piping is properly insulated                            |              |             |
| Unit performs COOL function properly                        |              |             |
| Unit performs HEAT function properly                        |              |             |
| Indoor unit louvers rotate properly                         |              |             |
| Indoor unit responds to remote controller                   |              |             |

## **DOUBLE-CHECK PIPE CONNECTIONS**

During operation, the pressure of the refrigerant circuit/piping will increase. This may reveal leaks that were not present during your initial leak check. Take time during the **Test Run** to double-check that all refrigerant pipe connection points do not have leaks. Refer to **Gas Leak Check** section for instructions.

5. After the Test Run is successfully completed, and you confirm all check points in List of Checks to Perform have passed, do the following:
  - a. Using the remote control, return unit to normal operating temperature.
  - b. Using insulation tape, wrap the indoor refrigerant pipe connections that you left uncovered during the indoor unit installation process.

## **IF THE AMBIENT TEMPERATURE IS BELOW 63°F (17°C)**

If the ambient temperature is below 63°F (17°C), the remote controller cannot be used to turn on the COOL function. In this instance, you will need to use the **MANUAL CONTROL BUTTON** to test the COOL function. Follow the steps below to access this function:

1. Lift the front panel of the indoor unit, and continue to raise it until it clicks into place and becomes self-supporting.
2. The **MANUAL CONTROL BUTTON** is located on the right-hand side of the unit (Refer to Fig 9.1). Press it 2 times to select the COOL function.
3. Perform Test Run as normal.

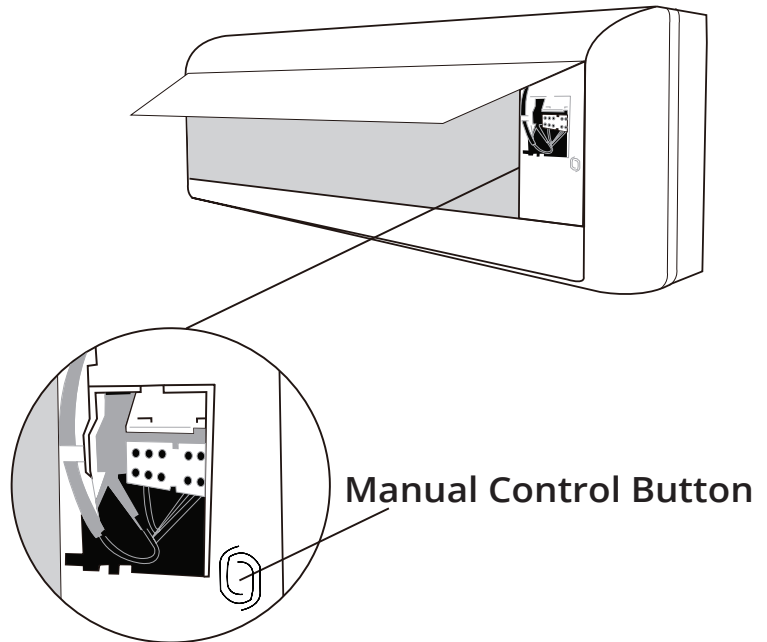

Fig. 9.1

## **! THANK YOU**

Thank you for purchasing a MRCOOL® ductless mini-split heating and air conditioning product.

MRCOOL® is a young, family-owned company, so we are truly thankful you trusted us with your business. Should you ever need technical support, or just have questions about your MRCOOL® product, or any of the other products we offer, please do not hesitate to call us at (270)-366-0457.

Also, if you can spare a few minutes today, and leave a review of your new MRCOOL® product on the partner site where you purchased it, it would really mean a lot to us. We are always looking for ways to improve, and real reviews, from actual customers like yourself, are vital and invaluable to our growing company.

Thank you for being a valued customer!

The following events may occur during normal operation, and may not indicate a malfunction.

| Symptom   | Cause   |
|---|---|
| Unit does not turn on when pressing <b>ON/OFF</b> button.       | The unit has a 3 minute protection feature that prevents the unit from overloading. The unit cannot be restarted within 3 minutes of being turned off.  |
| The unit changes from <b>COOL/HEAT</b> mode to <b>FAN</b> mode. | The unit may change its setting to prevent frost from forming on the unit. Once the temperature increases, the unit will start operating in the previously selected mode again.                                 |
|   | Once the set temperature has been reached, at this point the unit turns off the compressor. The unit will continue operating when the temperature fluctuates again.   |
| The indoor unit emits white mist.                               | In humid regions, a large temperature difference between the room's air and the conditioned air can cause a white mist to occur.  |
| Indoor and outdoor units emit a white mist.                     | When the unit restarts in <b>HEAT</b> mode after defrosting, a white mist may be emitted due to moisture generated from the defrosting process.   |
| The indoor unit makes noises.                                   | The sound of rushing air may occur when the louver resets it's position.  |
|   | A squeaking sound may occur after running the unit in <b>HEAT</b> mode due to the expansion and contraction of the unit's plastic parts.  |
| Indoor unit and outdoor unit make noises.                       | A low hissing sound during operation: This is normal and is caused by refrigerant gas flowing through both indoor and outdoor units.  |
|   | A low hissing sound when the system starts, has just stopped running, or is defrosting: This noise is normal and is caused by the refrigerant gas changing direction or stopping.                               |
|   | Squeaking sound: Normal expansion and contraction of the plastic and metal parts caused by temperature changes during operation can cause squeaking noises.   |
| The outdoor unit makes noises.                                  | The unit will make different noises based on which mode it is currently operating in.   |
| Dust is emitted from the indoor or outdoor unit.                | The unit may accumulate dust during extended periods of not being used, which will be emitted when the unit is turned on. This can be mitigated by covering the unit during any long periods of inactivity.     |
| The unit emits a bad odor.                                      | The unit may absorb odors from the environment (such as furniture, cooking, cigarettes, etc.) which will be emitted during operations.  |
|   | The unit's filters have become moldy and should be cleaned.   |
| Outdoor unit fan does not operate.                              | During operation, the fan speed is controlled to optimize product operation.  |
| Operation is erratic, unpredictable, or unit is unresponsive.   | Interference from cell phone towers and remote boosters may cause the unit to malfunction.  |
|   | If this is the case, try the following: <ul style="list-style-type: none"> <li>• Disconnect the power, then reconnect.</li> <li>• Press <b>ON/OFF</b> button on remote control to restart operation.</li> </ul> |

**NOTE:** If problem persists, contact a local dealer or your nearest customer service center. Provide them with a detailed description of the unit malfunction as well as the model number of your unit.



## WARNING

In the case of any of the following, turn off the unit immediately!

- Signal/power cable is damaged or abnormally warm
- Burning odor
- Loud or abnormal sounds
- A power fuse or circuit breaker trips frequently
- Water or other objects fall into or out of the unit

**DO NOT ATTEMPT TO CORRECT OR FIX THESE ITEMS YOURSELF!**

**CONTACT AN AUTHORIZED SERVICE PROVIDER IMMEDIATELY!**

Before calling for service assistance, troubleshoot a problem by performing the following checks:

| Symptom   | Possible Causes  | Solution   |
|---|--|--|
| Poor Cooling Performance                          | Temperature setting may be higher than ambient room temperature.   | Lower the temperature setting  |
|   | The heat exchanger on the indoor or outdoor unit is dirty.   | Clean the affected heat exchanger  |
|   | The air filter is dirty.   | Remove the filter and clean it according to the instructions.              |
|   | The air inlet or outlet of either unit is blocked.   | Turn the unit off, remove the obstruction and turn it back on.             |
|   | Doors and windows are open.  | Ensure all windows and doors are closed while operating the unit.          |
|   | Excessive heat is generated by sunlight.   | Close windows and curtains during periods of high heat or bright sunshine. |
|   | Too many other sources of heat in the room (people, computers, electronics, etc.)                                  | Reduce the amount of heat sources  |
|   | Low refrigerant due to a leak or long-term use.  | Check for leaks, reseal if necessary and top off the refrigerant level.    |
| SILENCE function is activated (optional feature). | The SILENCE function can lower product performance by reducing operating frequency. Turn off the SILENCE function. |  |
| The unit is not working                           | Power failure  | Wait for power to be restored  |
|   | The power is turned off  | Turn on the power  |
|   | The fuse is burned out   | Replace the fuse   |
|   | Remote control batteries are dead  | Replace the batteries  |
|   | The unit's 3 minute protection feature has been activated  | Wait three minutes after restarting the unit                               |
|   | Timer is activated   | Turn timer off.  |
| The unit starts and stops frequently              | There's too much or too little refrigerant in the system   | Check for leaks and recharge the system with refrigerant.                  |
|   | Incompressible gas or moisture has entered the system.   | Evacuate and recharge the system with refrigerant.                         |
|   | The compressor is broken.  | Replace the compressor.  |
|   | The voltage is too high or too low.  | Install a manostat to regulate the voltage.                                |
| Poor heating performance                          | The outdoor temperature is extremely low.  | Use auxiliary heating device.  |
|   | Cold air is entering through doors and windows   | Make sure that all doors and windows are closed during use.                |
|   | Low refrigerant due leak or long-term use  | Check for leaks, re-seal if necessary and top off refrigerant              |

# Troubleshooting

| Symptom  | Solution  |
|--|---|
| <b>Indicator lamps continue flashing</b><br><b>Error code appears and begins with the letters, as shown below in window display of the indoor unit:</b> <ul style="list-style-type: none"> <li>• EH(xx), EL(xx), EC(xx)</li> <li>• PC(xx)</li> </ul> | <b>The unit may stop operation or continue to run safely. If the indicator lamps continue to flash or error codes appear, wait for roughly 10 minutes. The problem may resolve itself. If not, disconnect the power, then connect it again. Turn the unit on. If the problem persists, disconnect the power and contact your nearest customer service center.</b> |

## Indoor Unit Error Display

When the indoor unit encounters a recognized error, the operation lamp will flash in a corresponding series, the timer lamp may turn on or begin flashing, and an error code will be displayed. These error codes are described in the table below:

| Operation Lamp | Timer Lamp | LED Display  | Error Information  | Solution (section) |
|----------------|------------|--------------|--|--------------------|
| 1 time         | OFF        | <b>EH 00</b> | Indoor unit EEPROM parameter error.  | 10.1               |
| 2 times        | OFF        | <b>EL 01</b> | Indoor / outdoor unit communication error.   | 10.2               |
| 3 times        | OFF        | <b>EH 02</b> | Zero-crossing signal detection error (for some models).  | 10.3               |
| 4 times        | OFF        | <b>EH 03</b> | The indoor fan speed is operating outside of the normal range.   | 10.4               |
| 5 times        | OFF        | <b>EC 51</b> | Outdoor unit EEPROM parameter error (for some models).   | 10.1               |
| 5 times        | OFF        | <b>EC 52</b> | Condenser coil temperature sensor T3 is in open circuit or has short circuited.  | 10.5               |
| 5 times        | OFF        | <b>EC 53</b> | Outdoor room temperature sensor T4 is in open circuit or has short circuited.  | 10.5               |
| 5 times        | OFF        | <b>EC 54</b> | Compressor discharge temperature sensor TP is in open circuit or has short circuited.                                  | 10.5               |
| 5 times        | OFF        | <b>EC 56</b> | Evaporator coil outlet temperature sensor T2B is in open circuit or has short circuited (for free-match indoor units). | 10.5               |
| 6 times        | OFF        | <b>EH 60</b> | Indoor room temperature sensor T1 is in open circuit or has short circuited.   | 10.5               |
| 6 times        | OFF        | <b>EH 61</b> | Evaporator coil temperature sensor T2 is in open circuit or has short circuited.                                       | 10.5               |
| 12 times       | OFF        | <b>EC 07</b> | The outdoor fan speed is operating outside of the normal range (for some models).                                      | 10.4               |
| 9 times        | OFF        | <b>EH 0b</b> | Indoor PCB / Display board communication error.  | 10.6               |
| 8 times        | OFF        | <b>EL 0c</b> | Refrigerant leak detected.   | 10.7               |
| 7 times        | FLASH      | <b>PC 00</b> | IPM malfunction or IGBT over-strong current protection.  | 10.8               |
| 2 times        | FLASH      | <b>PC 01</b> | Over voltage or over low voltage protection.   | 10.9               |
| 3 times        | FLASH      | <b>PC 02</b> | High temperature protection of IPM module or high pressure protection (for some models).                               | 10.10              |
| 5 times        | FLASH      | <b>PC 04</b> | Inverter compressor drive error.   | 10.12              |
| 1 time         | FLASH      | <b>PC 08</b> | Current overload protection (for some models).   | 10.13              |
| 7 times        | FLASH      | <b>PC 03</b> | Low pressure protection (for some models).   | 10.11              |
| 1 times        | ON         | --           | Indoor units mode conflict (match with multi outdoor unit).  | --                 |

## WARNING

The error codes above and descriptions on the following pages are for reference only. ***DO NOT*** attempt these repairs yourself, as doing this could cause personal injury, damage to your unit, and/or void the warranty. Should your unit display any of the error codes above, turn off the unit and contact a qualified service technician to investigate the matter further.

# Troubleshooting

## For other errors:

The display board may show a garbled code or a code undefined by the service manual. Ensure that this code is not a temperature reading.

## Troubleshooting:

Test the unit using the remote control. If the unit does not respond to the remote, the indoor PCB requires replacement. If the unit responds, the display board requires replacement.

## LED flash frequency:

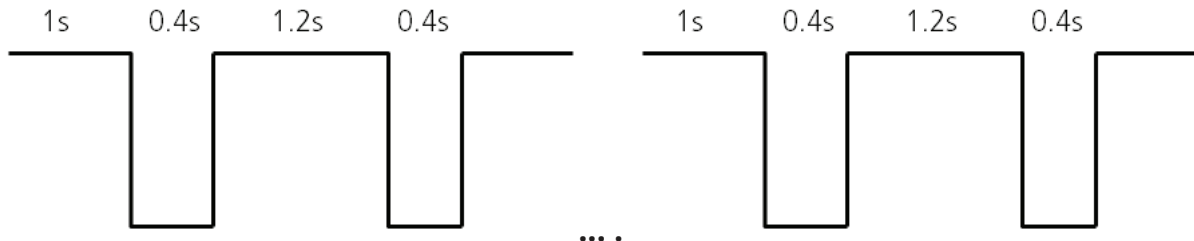

## Error Display (For Some Outdoor Units)

There are 2 LED lights (RED color and GREEN color) welded in outdoor main board. After power on, LED show different.

| No. | Problem  | LED(GREEN)   | LED(RED)     | Solution (section) |
|-----|--|--------------|--------------|--------------------|
| 1   | Standby normally   | <b>ON</b>    | <b>OFF</b>   | -                  |
| 2   | Operate normally   | <b>OFF</b>   | <b>ON</b>    | -                  |
| 3   | Compressor driven chip EEPROM parameter error                            | <b>ON</b>    | <b>FLASH</b> | 10.2               |
| 4   | IPM malfunction or IGBT over-strong current protection                   | <b>Flash</b> | <b>OFF</b>   | 10.9               |
| 5   | Over voltage or too low voltage protection                               | <b>ON</b>    | <b>ON</b>    | 10.10              |
| 6   | Inverter compressor drive error  | <b>OFF</b>   | <b>FLASH</b> | 10.11              |
| 7   | Inverter compressor drive error  | <b>Flash</b> | <b>LIGHT</b> | 10.11              |
| 8   | Communication error between outdoor main chip and compressor driven chip | <b>flash</b> | <b>FLASH</b> | 10.2               |

### \*\*\*\*Disclaimer\*\*\*\*

The error codes and descriptions are for reference only. If your system displays any of these codes contact a qualified technician to investigate the matter further.



## Troubleshooting by Error Code

### 10.1 Error Code: EH 00/EC 51 (EEPROM parameter error diagnosis and solution)

**Description:** Indoor or outdoor PCB main chip does not receive feedback from EEPROM chip.

**Recommended parts to prepare:**

- Indoor PCB
- Outdoor PCB

**Troubleshooting and repair:**

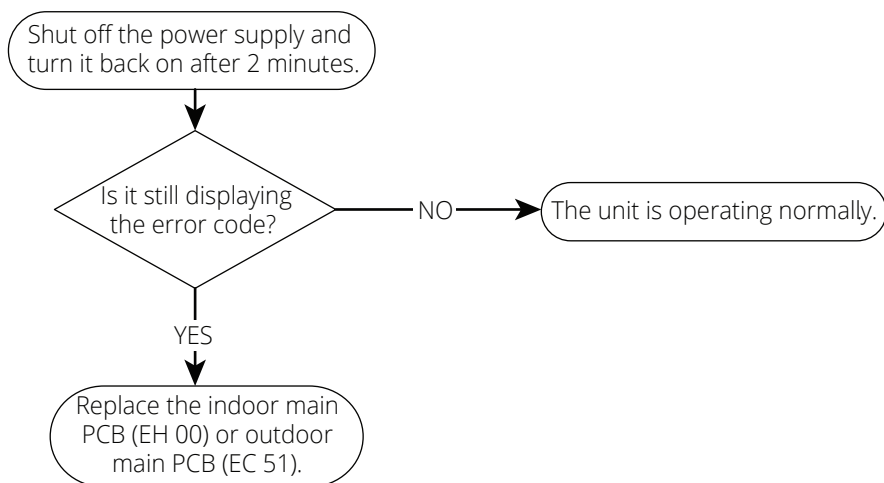

**Remarks:**

**EEPROM:** A read-only memory whose contents can be erased and reprogrammed using a pulsed voltage.

The location of the EEPROM chip on the indoor and outdoor PCB is shown in the following two images:

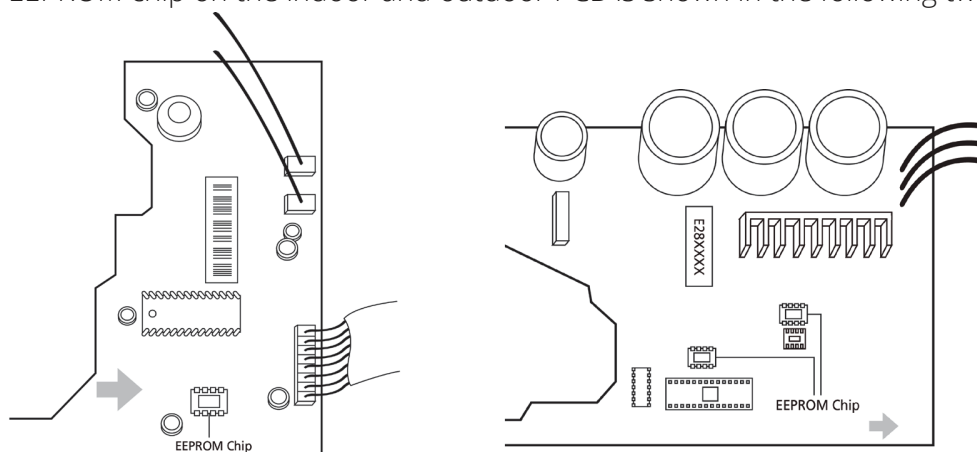

**Note:** For certain models, outdoor PCB could not be removed separately. In this case, the outdoor electric control box should be replaced as a whole. The pictures above are for reference only, actual appearance may vary.

Troubleshooting and repair of the compressor driven chip EEPROM parameter error and communication error between the outdoor main chip and compressor driven chip are the same as error code EC 51.

**\*\*\*\*Disclaimer\*\*\*\***

The error codes and descriptions are for reference only. If your system displays any of these codes contact a qualified technician to investigate the matter further.

# Troubleshooting

## 10.2 Error Code: EL 01 (Indoor and outdoor unit communication error diagnosis and solution)

**Description:** Indoor unit can not communicate with outdoor unit

**Recommended parts to prepare:**

- Indoor PCB
- Outdoor PCB
- Short-circuited component

**Troubleshooting and repair:**

**Note:** For certain models, outdoor PCB could not be removed separately. In this case, the outdoor electric control box should be replaced as a whole.

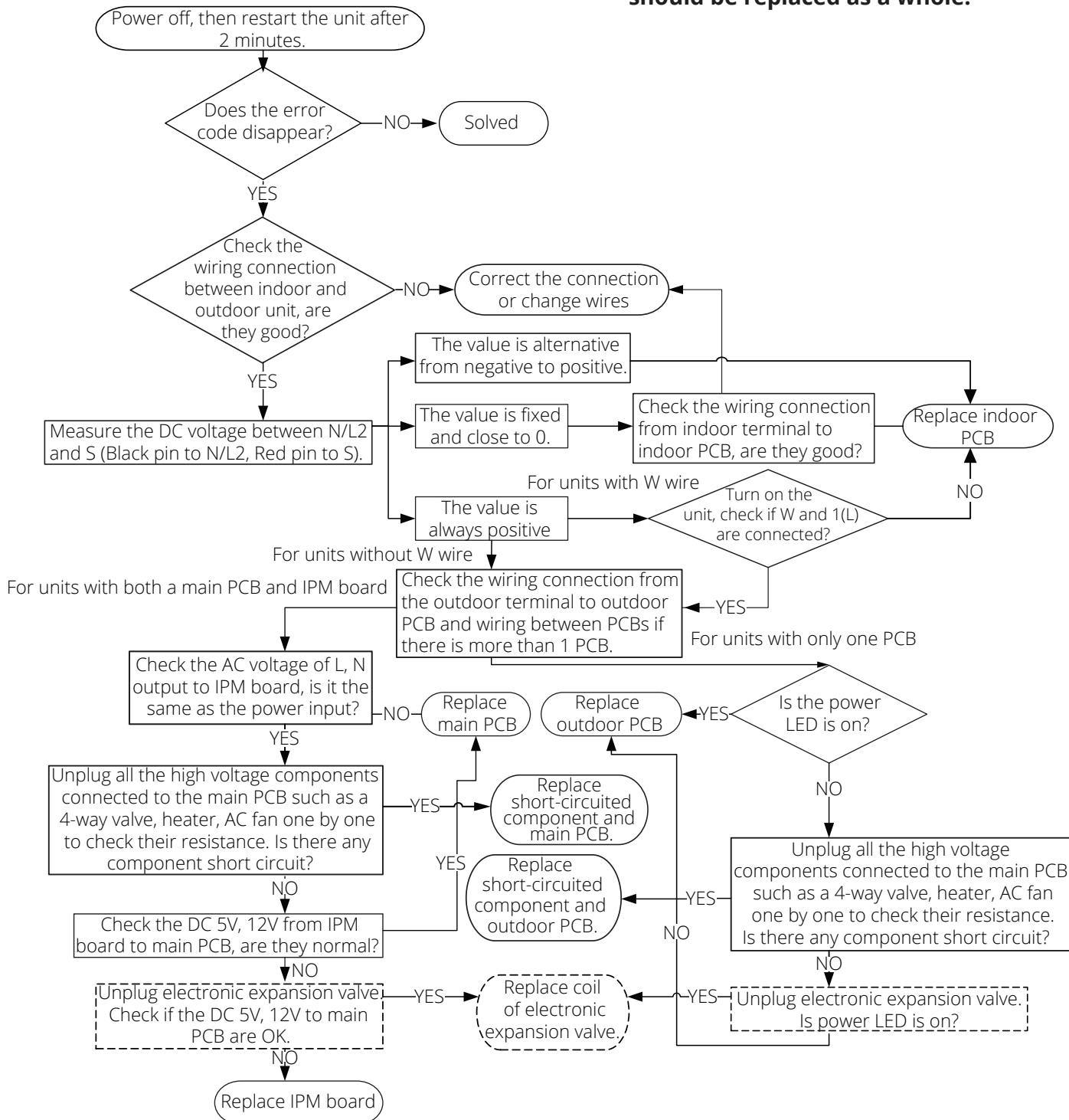

**\*\*\*\*Disclaimer\*\*\*\***

**The error codes and descriptions are for reference only. If your system displays any of these codes contact a qualified technician to investigate the matter further.**

# Troubleshooting

## Remarks:

- Use a multimeter to test the DC voltage between 2 port(or S or L2 port) and 3 port(or N or S port) of the outdoor unit. The red pin of the multimeter connects with 2 ports (or S or L2 port) while the black pin is for 3 port (or N or S port).
- When AC is normal running, the voltage is moving alternately as positive values and negative values
- If the outdoor unit has malfunction, the voltage has always been the positive value.
- While if the indoor unit has malfunction, the voltage has always been a certain value.

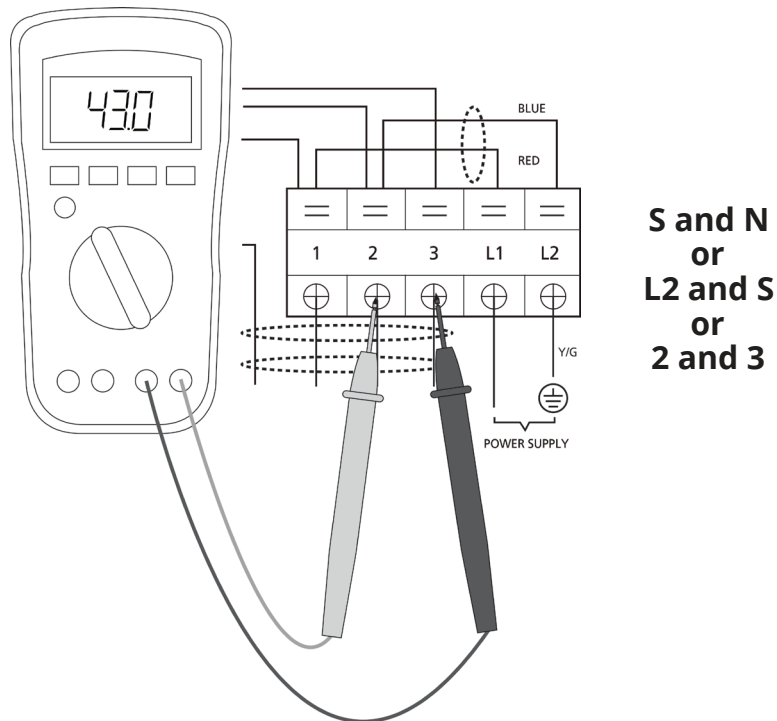

- Use a multimeter to test the resistance of the reactor which does not connect with capacitor.
- The normal value should be around zero ohm. Otherwise, the reactor must have malfunction.

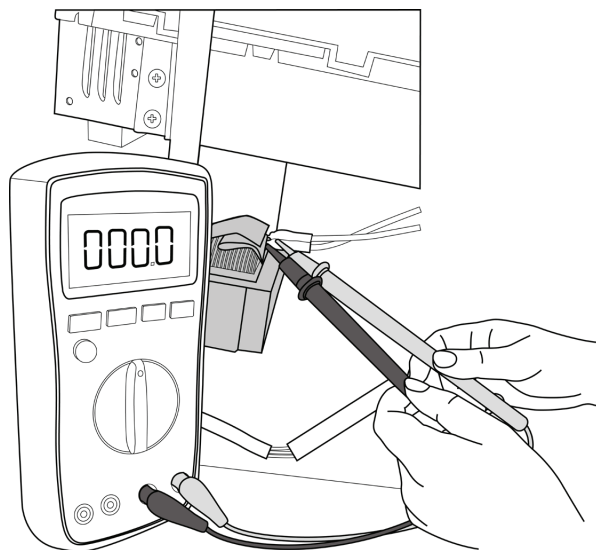

**Note: The picture and the value are only for reference, actual condition and specific value may vary.**

### \*\*\*\*Disclaimer\*\*\*\*

**The error codes and descriptions are for reference only. If your system displays any of these codes contact a qualified technician to investigate the matter further.**

# Troubleshooting

## 10.3 Error Code: EH 02 (Zero crossing detection error diagnosis and solution)

**Description:** When PCB does not receive zero crossing signal feedback for 4 minutes or the zero crossing signal time.

### Recommended parts to prepare:

- Connection wires
- PCB

**Note:** For certain models, the outdoor PCB cannot be removed separately. In this case, the outdoor electric control box should be replaced as a whole.

### Troubleshooting and repair:

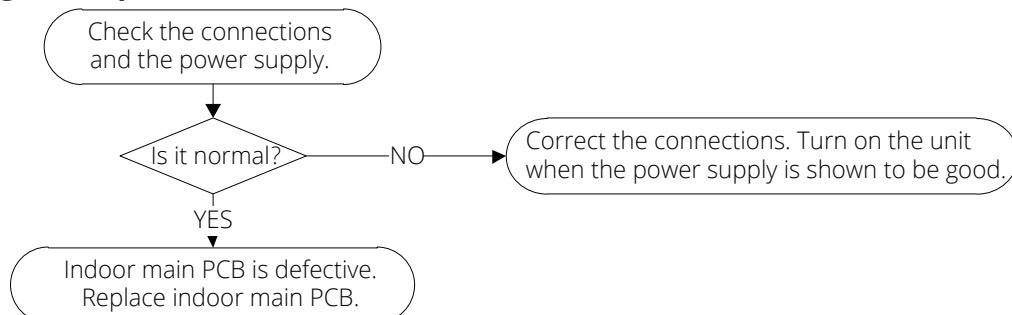

## 10.4 Error Code(s): EH 03 / EC 07 (Fan speed is operating outside of normal range diagnosis and solution)

**Description:** When indoor/outdoor fan speed is too low or too high for a certain amount of time, the LED displays the failure code and the A/C turns off.

### Recommended parts to prepare:

- Connection wires
- Fan assembly
- Fan motor
- PCB

### Troubleshooting and repair:

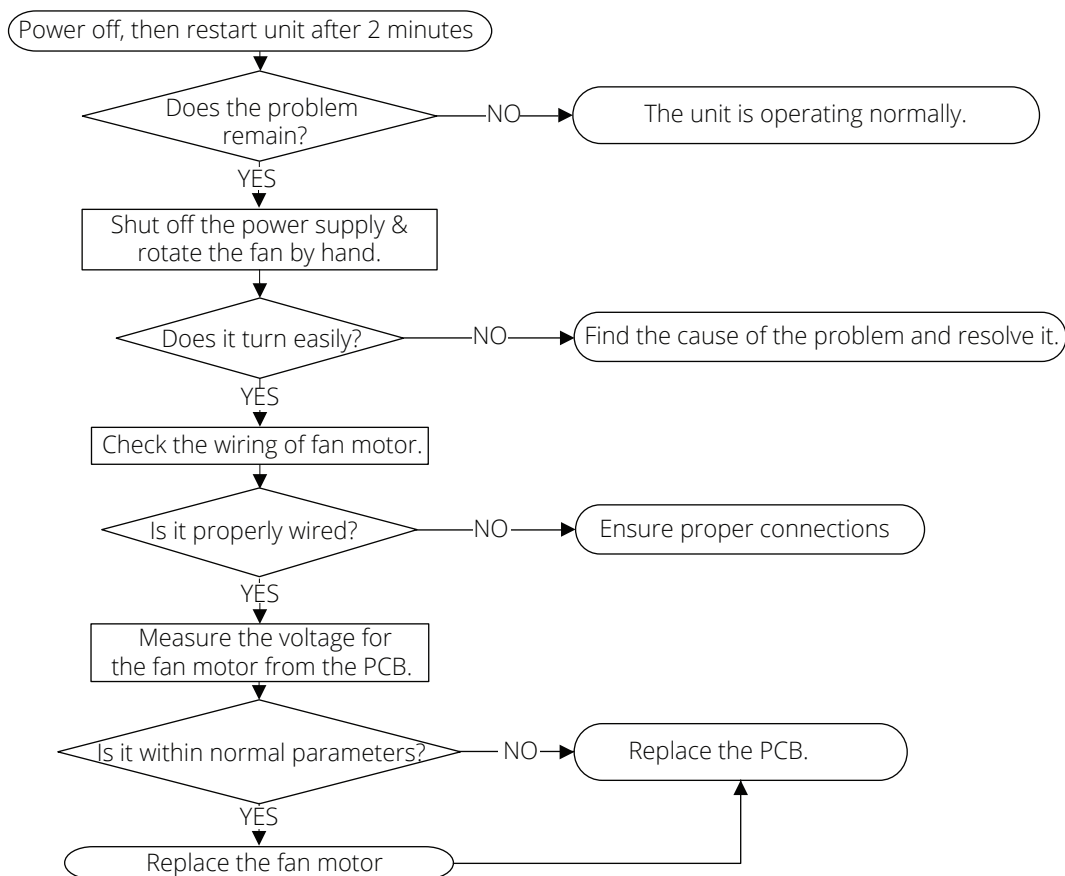

**Disclaimer:** The error codes and descriptions are for reference only. If your system displays any of these codes contact a qualified technician to investigate the matter further.

# Troubleshooting

## Index:

### 1. Indoor or Outdoor DC Fan Motor(control chip is in fan motor)

Power on and when the unit is in standby, measure the voltage of pin1-pin3, pin4-pin3 in the fan motor connector. If the value of the voltage is not in the range shown in the table below, the PCB needs to be replaced.

- DC motor voltage input and output (voltage: 220-240V~):

| No. | Color  | Signal | Voltage   |
|-----|--------|--------|-----------|
| 1   | Red    | Vs/Vm  | 280V~380V |
| 2   | ---    | ---    | ---       |
| 3   | Black  | GND    | 0V        |
| 4   | White  | Vcc    | 14-17.5V  |
| 5   | Yellow | Vsp    | 0~5.6V    |
| 6   | Blue   | FG     | 14-17.5V  |

- DC motor voltage input and output (voltage: 115V~):

| No. | Color  | Signal | Voltage   |
|-----|--------|--------|-----------|
| 1   | Red    | Vs/Vm  | 140V~190V |
| 2   | ---    | ---    | ---       |
| 3   | Black  | GND    | 0V        |
| 4   | White  | Vcc    | 14-17.5V  |
| 5   | Yellow | Vsp    | 0~5.6V    |
| 6   | Blue   | FG     | 14-17.5V  |

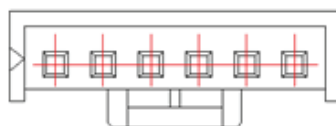

1 3 4 5 6  
Red Black White Yellow Blue

### 2. Outdoor DC Fan Motor (control chip is in outdoor PCB)

Release the UVW connector. Measure the resistance of U-V, U-W, V-W. If the resistance of each is not equal to one another, the fan motor needs to be replaced. If they are equal, the PCB needs to be replaced.

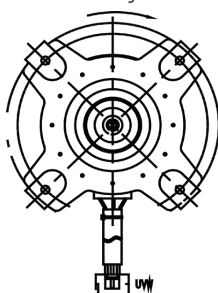

### 3. Indoor AC Fan Motor

Power on the unit and run it in fan mode with the fan speed setting set to high. After running for 15 seconds, measure the voltage of pin 1 and pin 2. If the value of the voltage is less than 100V (208~240V power supply) or 50V (115V power supply), the PCB needs to be replaced.

**\*\*\*\*Disclaimer\*\*\*\***  
**The error codes and descriptions are for reference only. If your system displays any of these codes contact a qualified technician to investigate the matter further.**

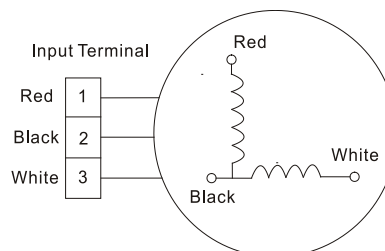

# Troubleshooting

## 10.5 Error Code(s): EH 60/EH 61/EC 52/EC 53/EC 54/EC 56 (Open circuit or short circuit of temperature sensor diagnosis and solution).

**Description:** If the sampling voltage is lower than 0.06V or higher than 4.94V, the LED displays the failure code.

### Recommended parts to prepare:

- Connection wires
- Sensors
- PCB

### Troubleshooting and repair:

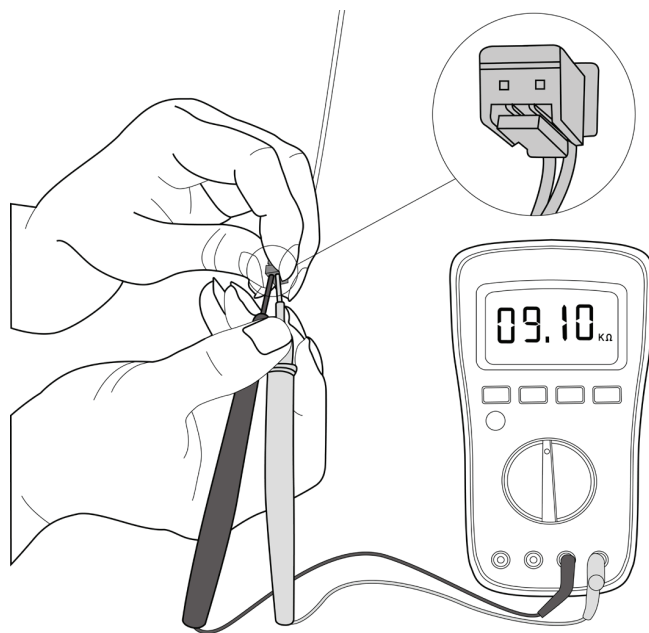
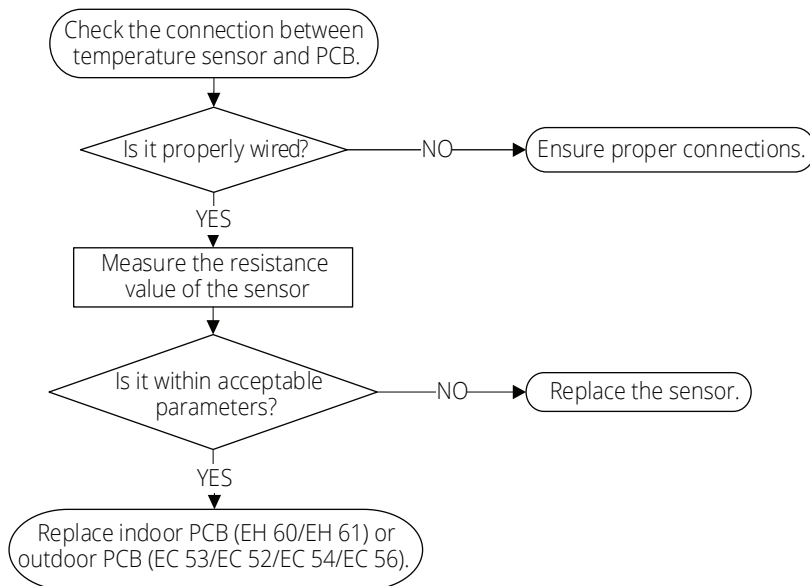

**Note:** For certain models, the outdoor PCB cannot be removed separately. In this case, the outdoor electric control box should be replaced as a whole. The illustration and value above are for reference only, actual appearance and value may vary.

### \*\*\*\*Disclaimer\*\*\*\*

The error codes and descriptions are for reference only. If your system displays any of these codes contact a qualified technician to investigate the matter further.



# Troubleshooting

## 10.6 Error Code: EH 0b (Indoor PCB / Display board communication error diagnosis and solution)

**Description:** Indoor PCB does not receive feedback from the display board.

### Recommended parts to prepare:

- Communication wire
- Indoor PCB
- Display board

### Troubleshooting and repair:

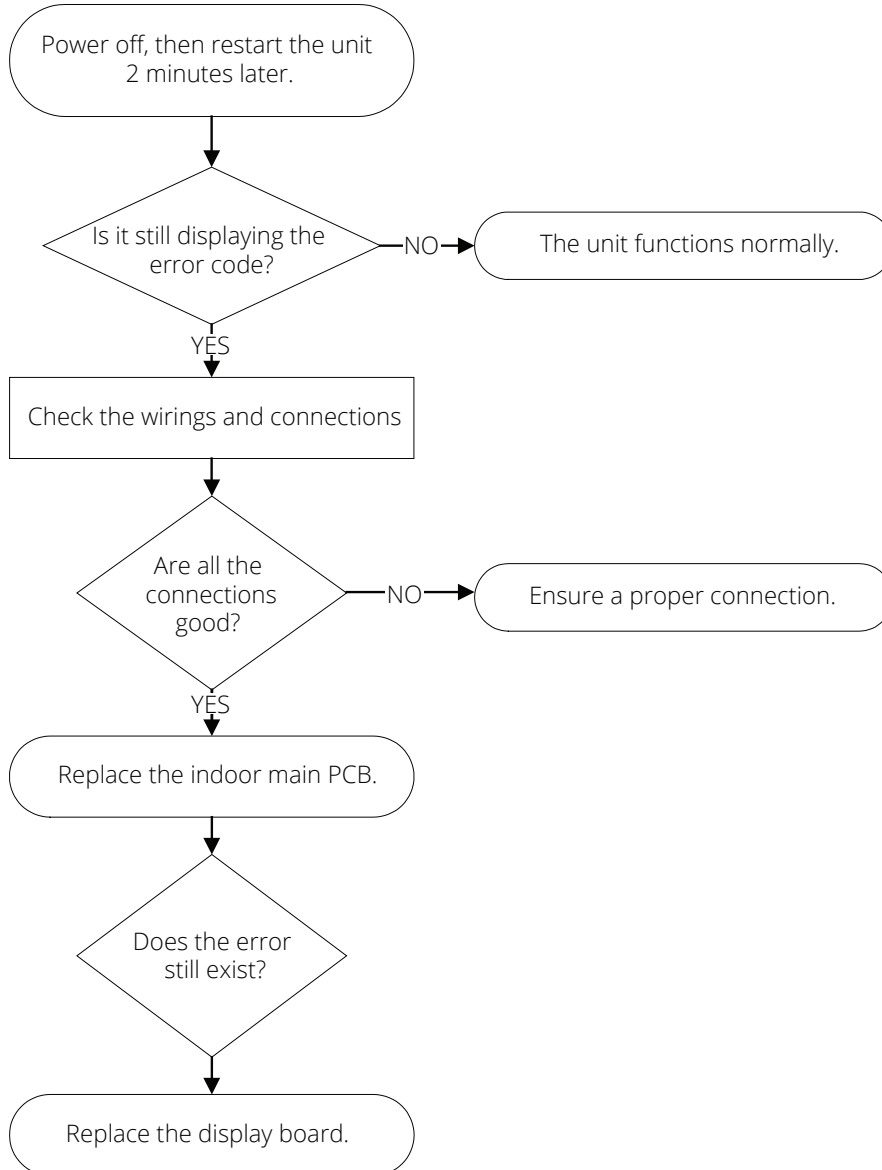

**\*\*\*\*Disclaimer\*\*\*\***

The error codes and descriptions are for reference only. If your system displays any of these codes contact a qualified technician to investigate the matter further.

# Troubleshooting

## 10.7 Error Code: EL 0C (Refrigerant Leakage Detection diagnosis and solution)

**Description:** Measure the evaporator coil temperature (T2) of the compressor as it just starts running as Tcool. In the initial 5 minutes after the compressor starts up, if the following events occur 3 times, the LED will display the error code and the A/C will turn off.; if  $T2 < T_{cool}$  (by  $1.8^{\circ}\text{F}$  ( $-1^{\circ}\text{C}$ )) and does not remain continuous for 4 seconds, and the compressor running frequency does not remain higher than 50Hz for 3 minutes.

### Recommended parts to prepare:

- T2 sensor
- Indoor PCB
- Additional refrigerant

### Troubleshooting and repair:

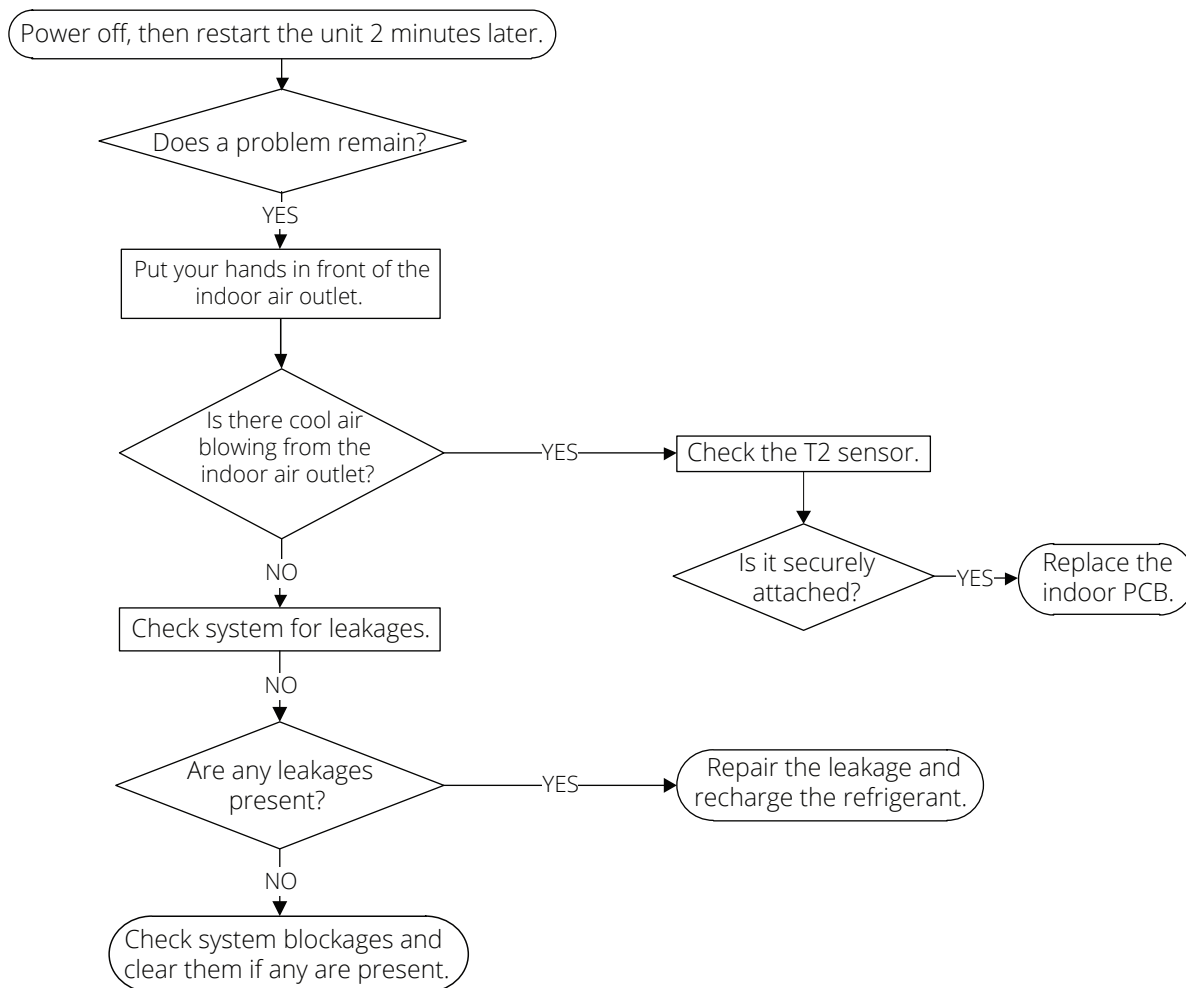

### \*\*\*\*Disclaimer\*\*\*\*

The error codes and descriptions are for reference only. If your system displays any of these codes contact a qualified technician to investigate the matter further.

# Troubleshooting

## 10.8 Error Code: PC 00 (IPM malfunction or IGBT over-strong current protection diagnosis and solution)

**Description:** When the voltage signal that the IPM sends to the compressor drive chip is abnormal, the LED will display the failure code and the A/C will turn off.

### Recommended parts to prepare:

- Connection wires
- IPM module board
- Outdoor fan assembly
- Compressor
- Outdoor PCB

### Troubleshooting and repair:

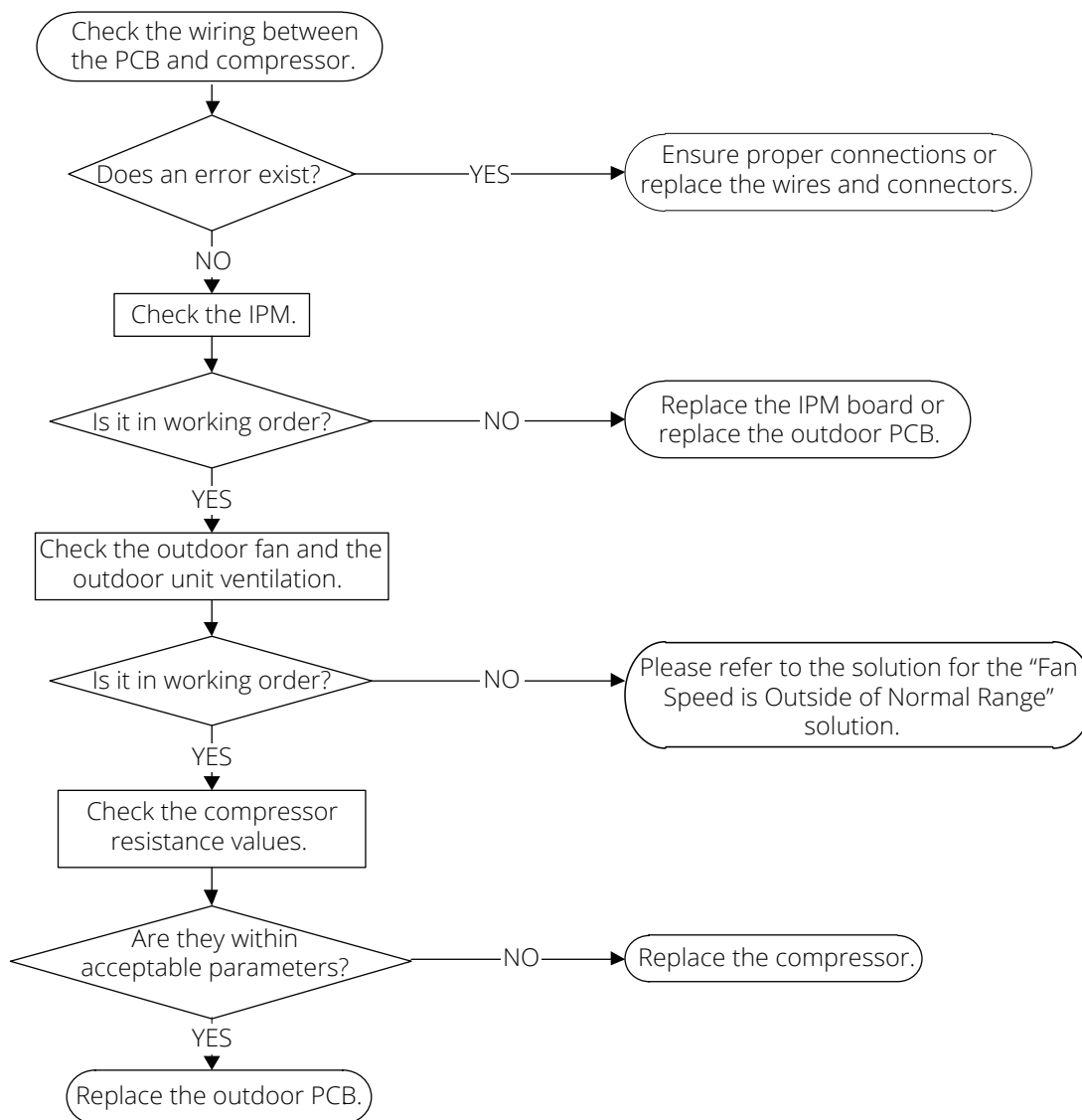

**Note:** For certain models, the outdoor PCB cannot be removed separately. In this case, the outdoor electric control box should be replaced as a whole.

### \*\*\*\*Disclaimer\*\*\*\*

The error codes and descriptions are for reference only. If your system displays any of these codes contact a qualified technician to investigate the matter further.

# Troubleshooting

## 10.9 Error Code: PC 01 (Over voltage or too low voltage protection diagnosis and solution)

**Description:** Abnormal increases or decreases in voltage are detected by checking the specified voltage detection circuit.

### Recommended parts to prepare:

- Power supply wires
- IPM module board
- PCB
- Reactor

### Troubleshooting and repair:

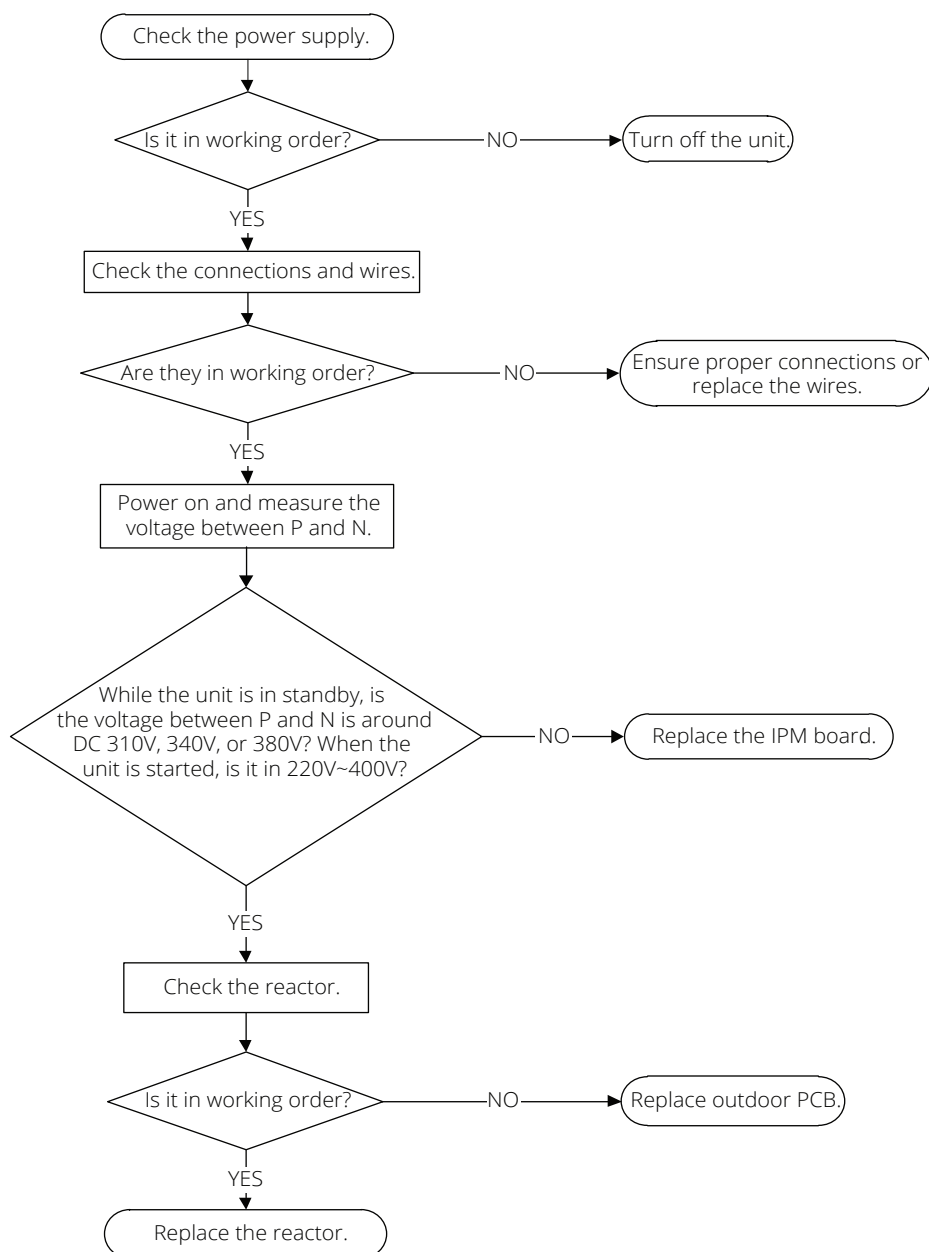

**Note:** For certain models, the outdoor PCB cannot be removed separately. In this case, the outdoor electric control box should be replaced as a whole.

**\*\*\*\*Disclaimer\*\*\*\***

**The error codes and descriptions are for reference only. If your system displays any of these codes contact a qualified technician to investigate the matter further.**

# Troubleshooting

## 10.10 Error Code: PC 02 (High temperature protection of IPM module or High pressure protection diagnosis and solution)

**Description:** If the temperature of the IPM module is higher than a certain value, the LED displays the failure code.

For some models with a high pressure switch, the outdoor pressure switch will cut off the system because the pressure is higher than 4.4 MPa. If this occurs, the LED will display the failure code.

### Recommended parts to prepare:

- Connection wires
- Outdoor PCB
- IPM module board
- High pressure protector
- System blockages

### Troubleshooting and repair:

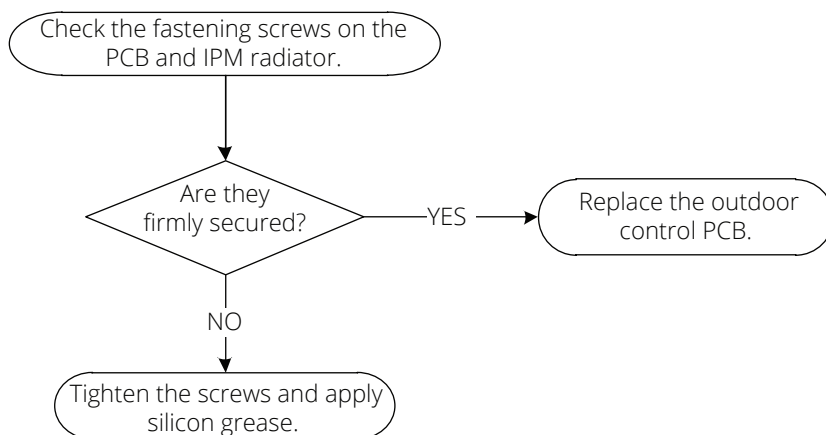

**Note:** For certain models, the outdoor PCB cannot be removed separately. In this case, the outdoor electric control box should be replaced as a whole.

### \*\*\*\*Disclaimer\*\*\*\*

The error codes and descriptions are for reference only. If your system displays any of these codes contact a qualified technician to investigate the matter further.



# Troubleshooting

## 10.10 Error Code: PC 02 (Cont.)

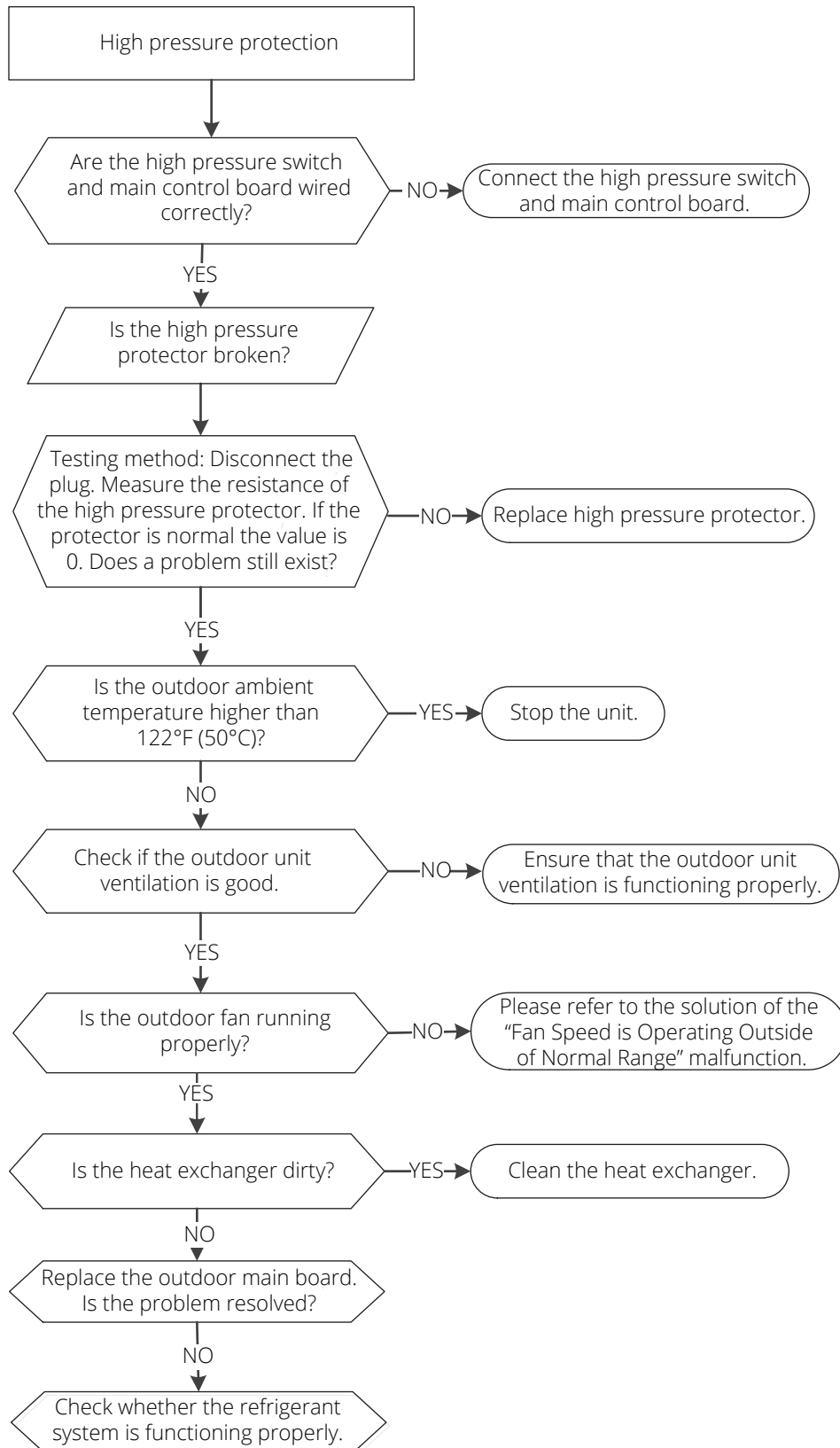

### \*\*\*\*Disclaimer\*\*\*\*

The error codes and descriptions are for reference only. If your system displays any of these codes contact a qualified technician to investigate the matter further.

# Troubleshooting

## 10.11 Error Code: PC 03 (Low pressure protection diagnosis and solution)

**Description:** Outdoor pressure switch cut off the system because pressure has become lower than 0.13 MPa. If this occurs, the LED will display the failure code.

### Recommended parts to prepare:

- Connection wires
- Outdoor PCB
- Low pressure protector
- Refrigerant

### Troubleshooting and repair:

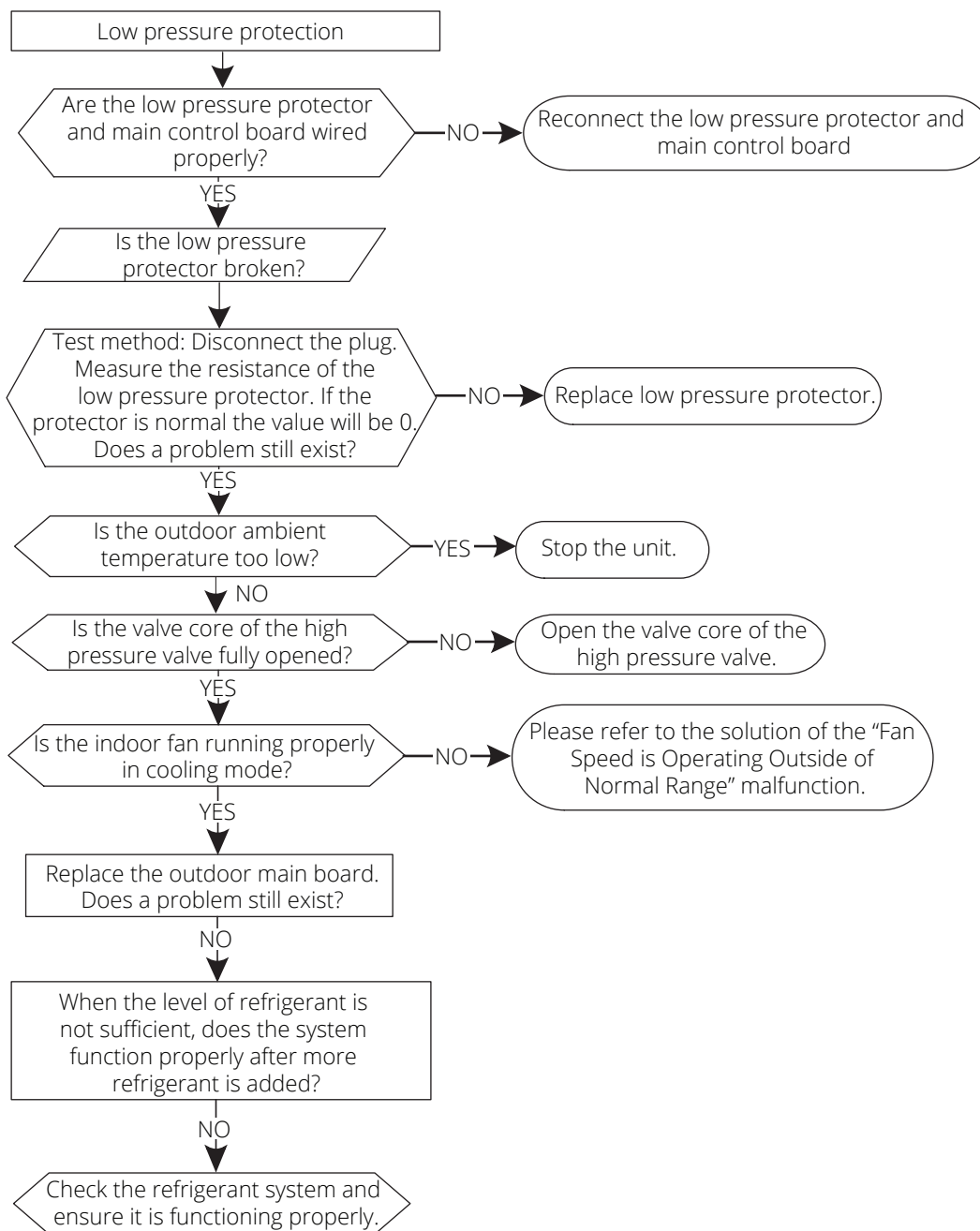

### \*\*\*\*Disclaimer\*\*\*\*

**The error codes and descriptions are for reference only. If your system displays any of these codes contact a qualified technician to investigate the matter further.**

## 10.12 Error Code: PC 04(Inverter compressor drive error diagnosis and solution)

**Description:** An abnormal inverter compressor drive is detected by a special detection circuit, including communication signal detection, voltage detection, compressor rotation speed signal detection and so on.

### Recommended parts to prepare:

- Connection wires
- IPM module board
- Outdoor fan assembly
- Compressor
- Outdoor PCB

### Troubleshooting and repair:

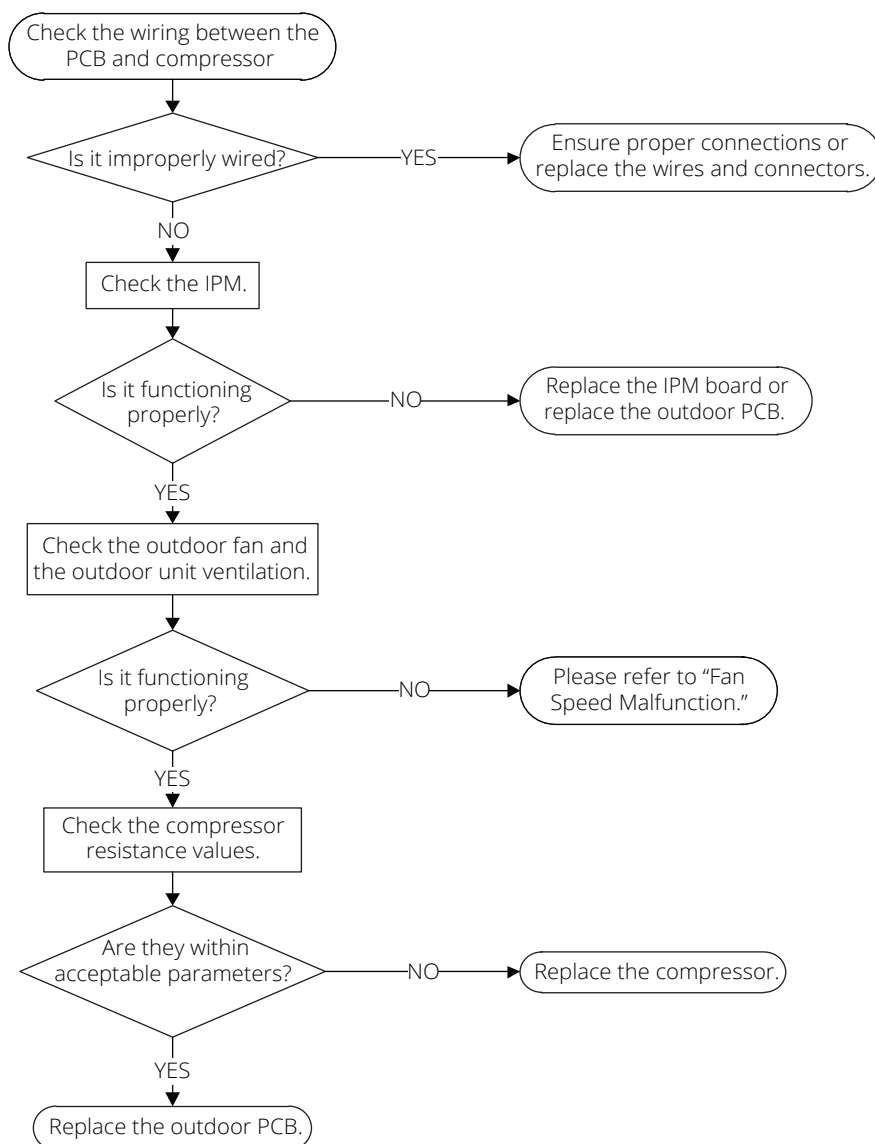

**Note:** For certain models, outdoor PCB could not be removed separately. In this case, the outdoor electric control box should be replaced as a whole.

### \*\*\*\*Disclaimer\*\*\*\*

The error codes and descriptions are for reference only. If your system displays any of these codes contact a qualified technician to investigate the matter further.

# Troubleshooting

## 10.13 Error Code: PC 08 (Overload current protection diagnosis and solution)

**Description:** An abnormal current rise is detected by checking the specified current detection circuit.

### Recommended parts to prepare:

- Outdoor PCB
- Connection wires
- Compressor

### Troubleshooting and repair:

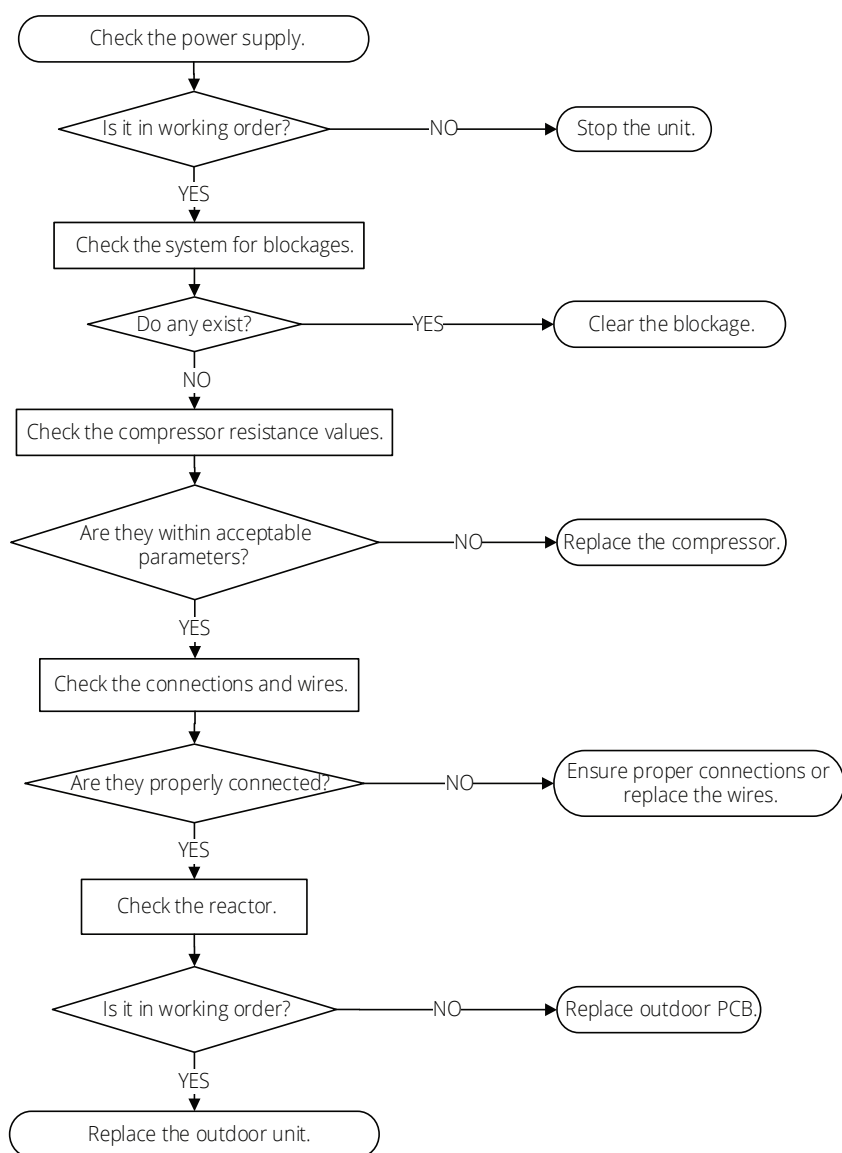

**Note:** For certain models, outdoor PCB could not be removed separately. In this case, the outdoor electric control box should be replaced as a whole.

### \*\*\*\*Disclaimer\*\*\*\*

The error codes and descriptions are for reference only. If your system displays any of these codes contact a qualified technician to investigate the matter further.

The marking shown below when depicted on the product or its literature, indicates that electrical waste and electrical equipment should not be mixed with general household waste.

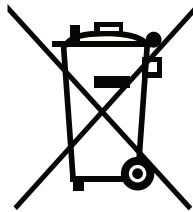

## Correct Disposal of This Product (Electrical Waste & Electronic Equipment)

This appliance contains refrigerant and other potentially hazardous materials. When disposing of this appliance, the law requires special collection and treatment.

**⊘ DO NOT dispose of this product as household waste or unsorted municipal waste.**

When disposing of this appliance, you have the following options:

- Dispose of the appliance at a designated municipal electronic waste collection facility.
- When buying a new appliance, the retailer will receive the old appliance free of charge.
- The manufacturer will receive the old appliance free of charge.
- Sell the appliance to certified scrap metal dealers.

### Special notice

Disposing of this appliance in the forest or other natural surroundings endangers your health and is bad for the environment. Hazardous substances may leak into the ground water and enter the food chain.





**MRCOOL®**

COMFORT MADE SIMPLE

**DIY® E Star™ Series**

Due to updates and constantly improving performance, the information and instructions within this manual are subject to change without notice. Please visit [www.mrcool.com/documentation](http://www.mrcool.com/documentation) to ensure you have the latest version of this manual.